

**FINAL**

**Ulster County Rail Trail Project – Ashokan Reservoir Section  
 (“Ashokan Rail Trail”)**

**Feasibility Study**

*prepared for*

The Open Space Institute



*and*

Ulster County

July 2015



This project is being designed using U.S. Customary units and the text of this report uses U.S. Customary units. The following table of approximate conversion factors provides the relationship between metric and U.S. Customary units for some of the more frequently used units in highway design. The table allows one to calculate the U.S. Customary Unit by multiplying the corresponding Metric Unit by the given factor.

	<u>Metric Unit</u>	x	<u>Factor</u>	=	<u>U.S. Customary Unit</u>
<u>Length</u>	kilometer (km)	x	0.621	=	miles (mi)
	meter (m)	x	3.281	=	feet (feet)
<u>Area</u>	hectare (ha)	x	2.471	=	acres (a)
	square meter (m <sup>2</sup> )	x	1.196	=	square yards (sy)
	square meter (m <sup>2</sup> )	x	10.764	=	square feet (sf)
<u>Volume</u>	cubic meter (m <sup>3</sup> )	x	1.308	=	cubic yards (cy)
	cubic meter (m <sup>3</sup> )	x	35.315	=	cubic feet (cf)
<u>Speed</u>	kilometer per hour (km/h)	x	0.621	=	miles per hour (mph)
	meter per second (m/s)	x	3.281	=	feet per second (feet/s)

**TABLE OF CONTENTS**

COVER (Title / Location) .....i

METRIC TO U.S. CUSTOMARY UNIT CONVERSION TABLE.....ii

CHAPTER 1 – EXECUTIVE SUMMARY / INTRODUCTION.....1-1

CHAPTER 2 – EXISTING CONDITIONS.....2-1

CHAPTER 3 – PROPOSED ALTERNATIVE.....3-1

CHAPTER 4 – ENVIRONMENTAL CONDITIONS.....4-1

<b>APPENDICES</b>	
A.	Preliminary Plans and Typical Sections
B.	Photo Log
C.	Preliminary Cost Estimate
D.	Boiceville Trestle Assessment
E.	Butternut Cove Assessment
F.	Environmental

## CHAPTER 1 - EXECUTIVE SUMMARY / INTRODUCTION

### Executive Summary

Barton and Loguidice, D.P.C. (B&L) was retained in 2014 by the Open Space Institute, Inc. (OSI) to conduct a feasibility study of recreational trail development on the Ulster & Delaware (U&D) Railroad corridor extending 11.5 miles from Basin Road in the Town of Hurley to NYS Route 28A in the Town of Olive. The feasibility study (FS) was funded by OSI, The Dyson Foundation, the Woodstock Land Conservancy, and private donors in Ulster County. The goal of the FS was to collect needed data and information on the County-owned corridor and provide a preliminary assessment on possible trail development alternatives.

The FS assessed existing conditions of the U&D corridor by breaking the corridor into five sections, all of which were surveyed, mapped, and inspected during multiple field visits. The FS identifies the proposed trail needs and objectives, analyzes potential alternative design considerations, and discusses potential environmental effects on the surrounding area resulting from the conversion of the railroad corridor to a multi-use, public recreational trail. The overall objectives of this evaluation were to physically inspect the proposed trail corridor and provide a site assessment and feasibility study for a future pedestrian/bicycle multi-use trail. This assessment and the supporting documentation will be provided to Ulster County to provide baseline data as the County moves forward with planning and design of the proposed trail. The existing conditions were evaluated based on the constructability of the proposed trail and trail user safety, and the report addresses various physical constraints that may prevent the standard trail section from being utilized, such as areas of narrow rock cut and fill side slopes.

The assessment found that conversion of the railroad corridor to a multi-use recreational trail is feasible from both an engineering and cost perspective. Logical trail access points were identified, which could provide easy public access to the future trail. The existing U&D corridor is largely intact and in good to fair condition although some areas exhibit signs of extended lack of maintenance, particularly for drainage structures. Engineering and construction of the trail would be relatively straightforward and uncomplicated with the exception of two major constraints that were identified and evaluated: the failing Butternut Creek Culvert and collapsed Boiceville Trestle. B&L has developed separate reports documenting the existing conditions of these specific project constraints and provided recommended solutions to repair the damages to these areas (See Appendices D and E).

The development of trail was estimated to cost \$4 to \$4.5 million, with the exception of the two major constraints, which can be progressed as separate projects. The reconstruction of the compromised Butternut Creek Culvert would be approximately \$1.1 to \$1.2 million, and the Boiceville Trestle would cost \$2.6 to \$4.2 million. Details regarding trail surface, safety fencing, trail amenities, and final locations for trailheads will be determined through a public planning and design process that will be progressed by Ulster County in coordination with the New York City Department of Environmental Protection.

The following figures display the location of the study area:

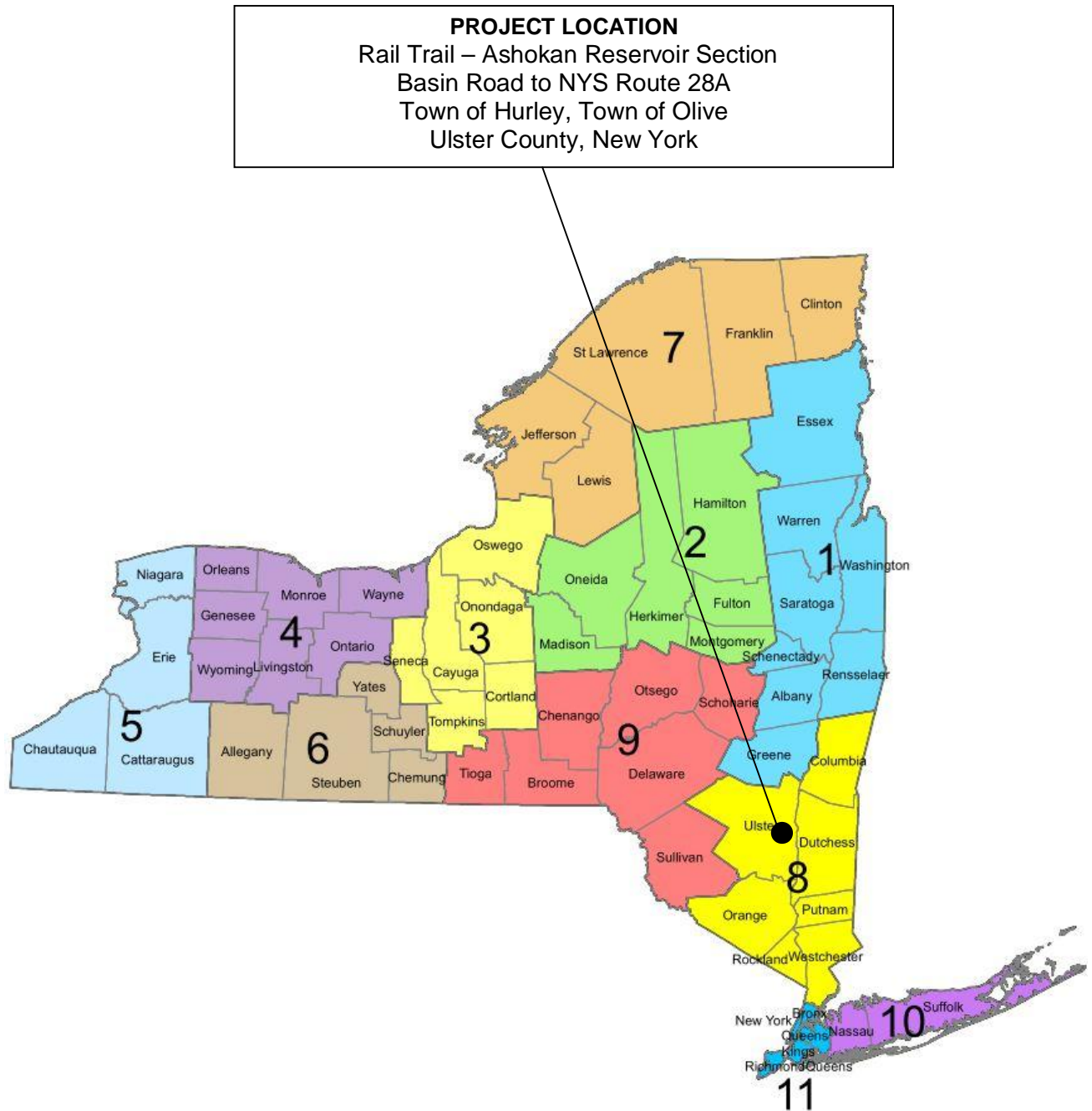
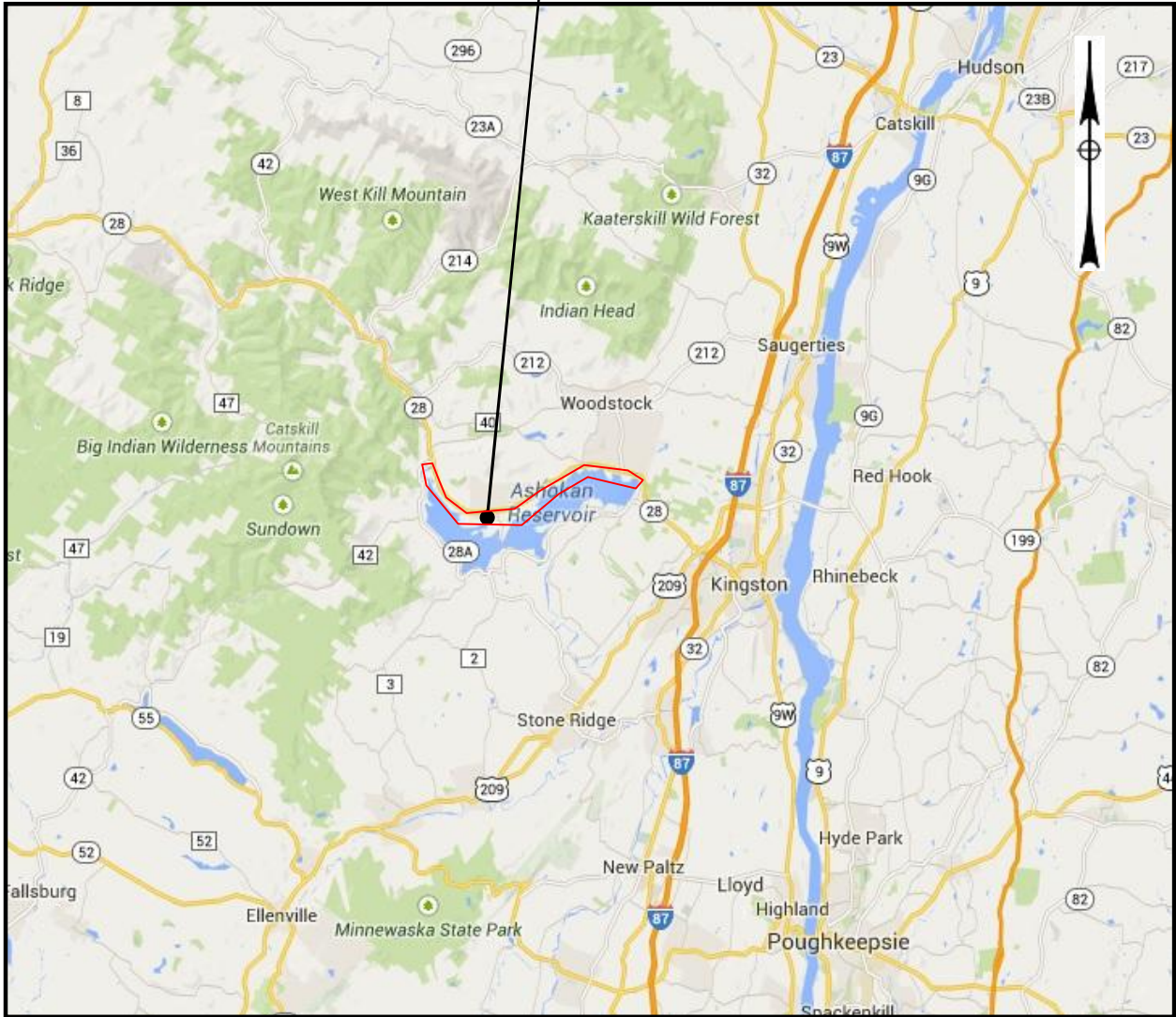

Figure 1 – New York State Map

**PROJECT LOCATION**  
Ulster County Rail Trail Project – Ashokan Reservoir Section  
Basin Road to NYS Route 28A  
Town of Hurley, Town of Olive  
Ulster County, New York



**Figure 2 – Project Location Map**

**PROJECT LOCATION**  
Ulster County Rail Trail Project – Ashokan Reservoir Section  
Basin Road to NYS Route 28A  
Town of Hurley, Town of Olive  
Ulster County, New York

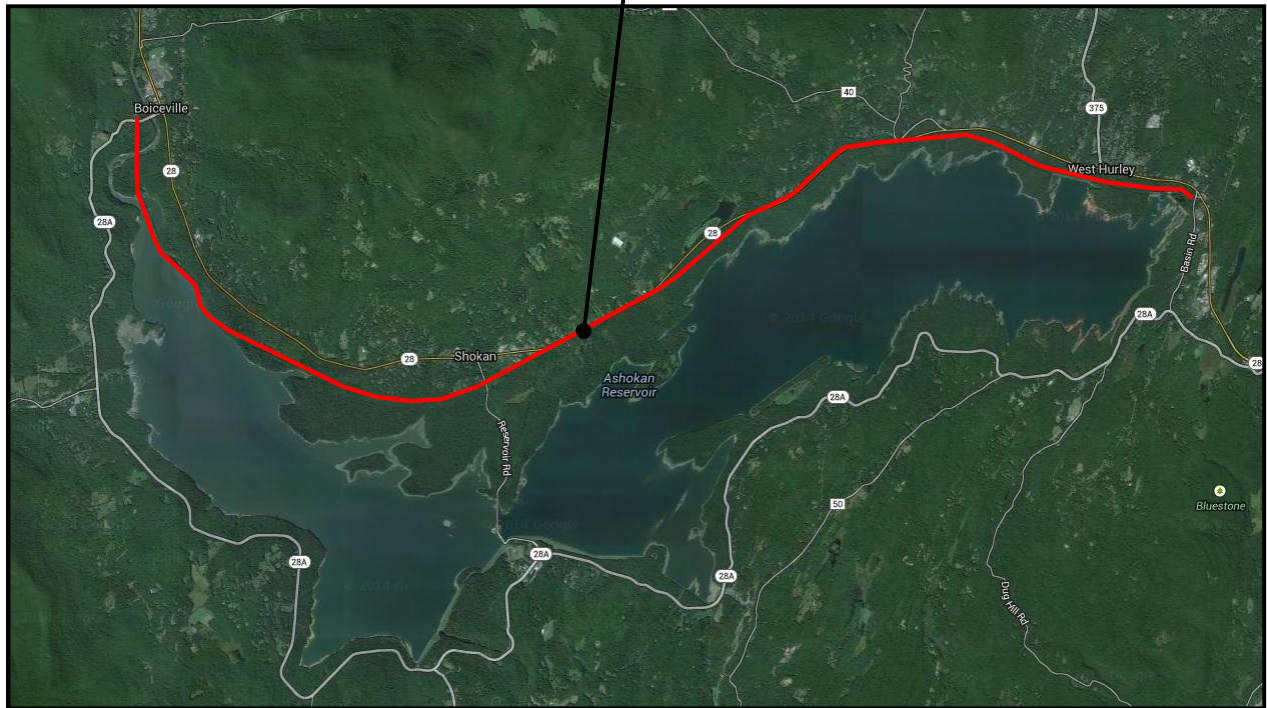

**Figure 3 – Project Corridor Map**

## Introduction

In 1979, Ulster County purchased from Penn Central Transportation Company 38.6 miles of right-of-way from Kingston to Highmount along the former Ulster & Delaware (U&D) Railroad, on which passenger service ended in 1954 and freight service ended in 1976. Ulster County purchased the U&D corridor with the goal of attracting a major steam railroad tourism development, which eventually located elsewhere. Beginning in 1983, the CMRR, a for-profit tourism railroad operator, signed a series of short leases of the rail corridor and began to operate on limited segments as a tourist railroad. In 1991, Ulster County and the CMRR contracted through a 25 year lease for use of the rail corridor, which concludes in May 2016. Ulster County is planning to develop a segmented rail and trail plan along the underutilized corridor, converting the entire Ashokan Reservoir section into a recreational trail only, which the NYCDEP has agreed to support and help fund. The County Executive's vision is to connect this section of trail to other regional trails and create a world-class tourism destination by linking trails from the Walkway Over the Hudson to the Ashokan Reservoir and Catskill Park.

This report will develop a preliminary assessment of the U&D corridor along the Ashokan Reservoir to determine how the existing railroad corridor could meet recommended standards for public multi-use recreational trails. This assessment will include preliminary construction cost estimates for sensible trail connection points, potential environmental impacts, and the necessary permits required for construction.

Two alternatives were originally considered for the Ashokan section of the corridor: the construction of a dedicated multi-use trail built on the existing railroad ballast and the construction of the multi-use trail adjacent to the railroad tracks, which would allow the railroad to remain. These alternatives are discussed in detail below:

- **Dedicated Multi-Use Trail (Alternative 1)** – The alternative is proposed to follow the Ulster & Delaware (U&D) railroad corridor for 11.5 miles, stretching between Basin Road and NYS Route 28A. All existing steel rails, wood railroad ties, unsuitable stone ballast, and other track materials would be removed allowing for the construction of a dedicated multi-use trail. Drainage pipes and culverts would be repaired or replaced to allow for continued use.

**Alternative 1A:** The recreational trail section will include varying characteristics throughout the corridor in order to reduce excavation quantities. The horizontal and vertical alignments of the trail will follow / remain on the existing railroad bed to the greatest extent possible.

**Alternative 1B:** The recreational trail section will remain similar throughout the corridor. Excavation of the existing embankment will be used to reduce the amount of pedestrian handrail required and to create a trail with a continuous appearance. The horizontal alignment of the trail will follow / remain on the existing railroad bed, however, the vertical alignment would be revised in order to provide a more continuous trail section as opposed to one that varied due to existing constraints.

- **Railroad and Dedicated Multi-Use Trail (Alternative 2)** – For this alternative, the public multi-use recreational trail would run parallel to the adjacent railroad bed for 11.5 miles, stretching between Basin Road and NYS Route 28A. The existing steel rails, wood railroad ties, stone ballast, and any additional railroad infrastructure would remain in place under this alternative. This alternative would require significant tree clearing, culvert and drainage pipe extensions, and earthwork (excavation and embankment). To provide a conservative average additional 10 feet in width through the corridor for proper clearances between the rail and a multi-use path would require more than 300,000 cubic yards of material placement. Just the material installation alone comes in at an estimated cost of more than \$12 Million. The additional cost of rehabilitating the deteriorating railroad infrastructure to satisfy minimum FRA Class 1 standards in addition to the previously mentioned improvements would likely exceed the \$12 Million significantly, with an estimated cost of \$24 Million to \$30 Million for upgrading the railroad to be operable and constructing co-located trail.



Based upon the 2014 Ulster County Legislature policy for development of *trail only* in the Ashokan Reservoir segment, the fiscal constraints of building rail alongside trail, and the Agreement between Ulster County and NYCDEP finalized in April 2015, the development of “rail plus trail” in this segment was not considered feasible or practical. Therefore, this study focused on conversion of the existing railroad footprint to trail only as proposed under Alternative 1.

Please refer to Chapter 3 – Proposed Conditions-- for a more detailed discussion and comparison of all alternatives initially considered.

## CHAPTER 2 - EXISTING CONDITIONS

This chapter addresses the existing conditions, deficiencies, and needs for the proposed trail corridor.

Photographs included within the text are included to provide the reader with an understanding of the existing conditions. Additional photos that are included in Appendix B are sometimes referenced for additional information for the reader.

**Overall Corridor Description** – A conditions assessment of the U&D corridor between mile posts K10 and K21.5 (11.5 miles) was completed between October 14, 2014 and October 20, 2014. The study corridor was divided into five (5) logical segments based on terrain, conditions, and constraints as a way to categorize the needs and opportunities in the respective segments. These segments are outlined in Figure 4 and further detailed in the following paragraphs. A control line with defined incremental stationing was applied to the corridor to aid in the location of features in the field and to efficiently correlate the data. This stationing can be viewed in detail on the figures included in Appendix A.

Overall, the adjacent land type of the corridor was rolling with varying sections of steep rock cuts, steep fill slopes, and areas that were generally flat on both sides of the railroad bed. The grade of the railroad bed was generally flat throughout (grades less than 1%) with elevation increasing by approximately 48 feet from Basin Road west to NYS Route 28A. Generally, the stone ballast was in good condition and would not require substantial amounts of effort to construct a trail, with the exception of a few specific areas mentioned in the descriptions below. While this assessment did not include the existing railroad ties and track, a track compliance inspection was conducted in 2014 by the rail group of the engineering firm HDR, which concluded the section of corridor from Hurley Mountain Road to the Boiceville Trestle, including the entire Ashokan Reservoir segment, does not meet minimum FRA Class 1 standards for railroad operation. A copy of this study is available by request.

The U&D Railroad right-of-way traverses Watershed lands owned, operated and patrolled by the New York City Department of Environmental Protection (NYC DEP). NYC DEP lands along the corridor are accessible by permit only in addition to hunting and fishing licenses for those permitted activities.

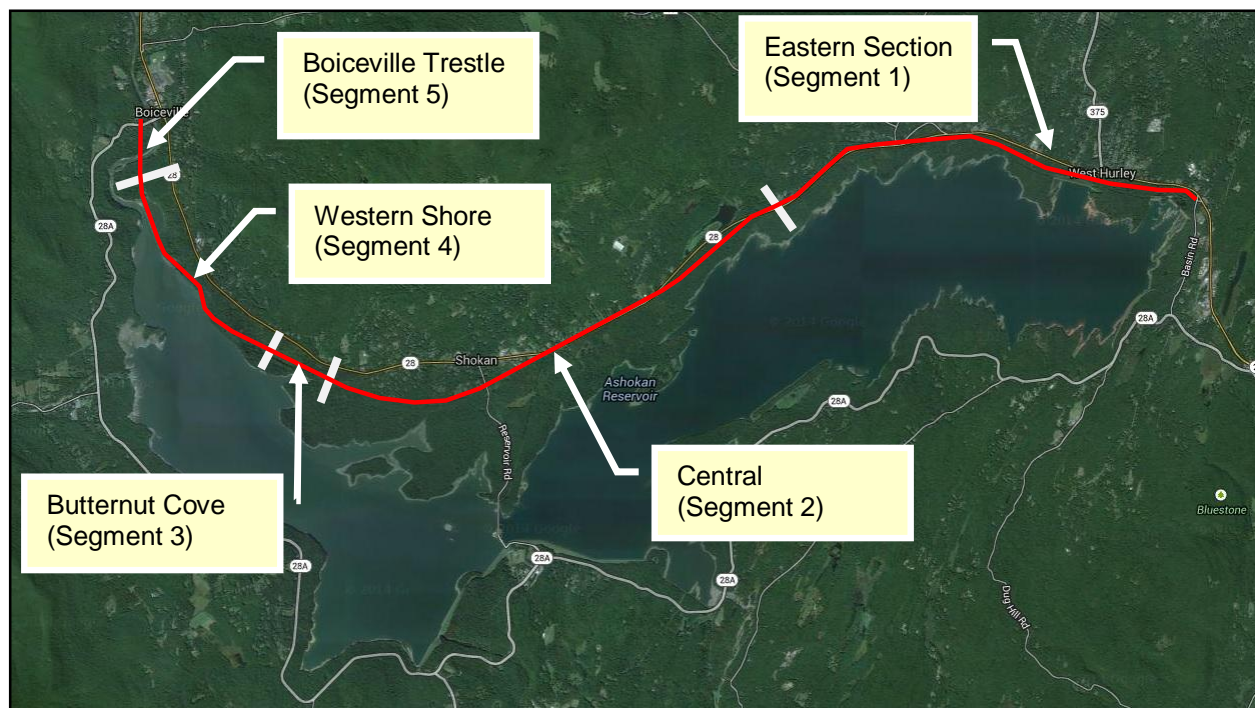

Figure 4 –Segmental Breakdown

**Existing Segment Conditions:**

**Ashokan Eastern Section (Segment 1)** – This section extends from the eastern most terminus of the project study area at the Basin Road overpass (milepost K10) approximately 4 miles west along the railroad corridor to milepost K14. Side slope conditions generally vary between rock cut sections and fill sections with steep slopes on both sides of the right-of-way. Stationing for this segment is between station 528+85 at the eastern end of the segment and station 739+80 at the western end of the segment.

**Railroad Infrastructure:** The remaining railroad infrastructure in this segment consists of steel rails, wooden ties, stone ballast, concrete signal foundations, and other miscellaneous track equipment. The steel rails in this segment are at a consistent gauge and still fastened to wooden ties that are in poor condition. An additional report examined the existing railroad tracks throughout the corridor and rated the corridor below Class 1 standards, which do not allow passenger trains to operate on the tracks. The report is available by request with Ulster County. Photo 1-1 (Segment 1, Photo1) below shows an example of remaining miscellaneous railroad track infrastructure found in this segment while Photo 1- 2 shows the typical railroad infrastructure conditions for this segment.



**Photo 1-1**– Example of Remaining Railroad Track Infrastructure – Segment 1



**Photo 1-2** – Existing Rail Infrastructure Conditions – Segment 1

**Vegetation:** The majority of the right-of-way is clear of vegetation that would require removal. One exception is between the 600' between station 625+85 and station 631+85, which will require the removal of minor pine tree growth (Photo 1-3) located in-between and adjacent to the tracks. Tree removal will also be required in various locations throughout the segment where drainage conveyance systems need to be restored or improved. Trees growing in drainage ditches inhibit the flow of storm water through the ditch and provide a location for debris to build up. Another location requiring vegetation removal is the top of the Glenford Dike, which consists mainly of brush and weed overgrowth. The remainder of the segment will require spot tree and brush removal to provide adequate clear width for the trail. Additional photos (104, 106 and 113) can be found in Appendix B that depict more of the general vegetative conditions found within this segment.



**Photo 1-3** – Minor Tree Growth

**Corridor Dimensions:** Segment 1 exhibits consistent characteristics along its length. The width of the stone ballast varies between 8 feet and 10 feet, measured from the left side of the ballast to the right.

The clear width of the segment ranged between 10 feet and 28 feet where clear width is defined as the measurement of the typical distance between trees. Vertical clearance to obstructions throughout the segment was typically 8 feet. Some minor trimming will be required to provide the recommended minimum vertical clearance of 10 feet. The width of the embankment in elevated (or “fill”) sections was generally consistent with the clear width of the segment. Figure 5 below shows an explanation of the measuring convention used throughout the corridor. Included in Appendix B are additional photos (105 -107) that also depict the typical rail corridor dimensions.

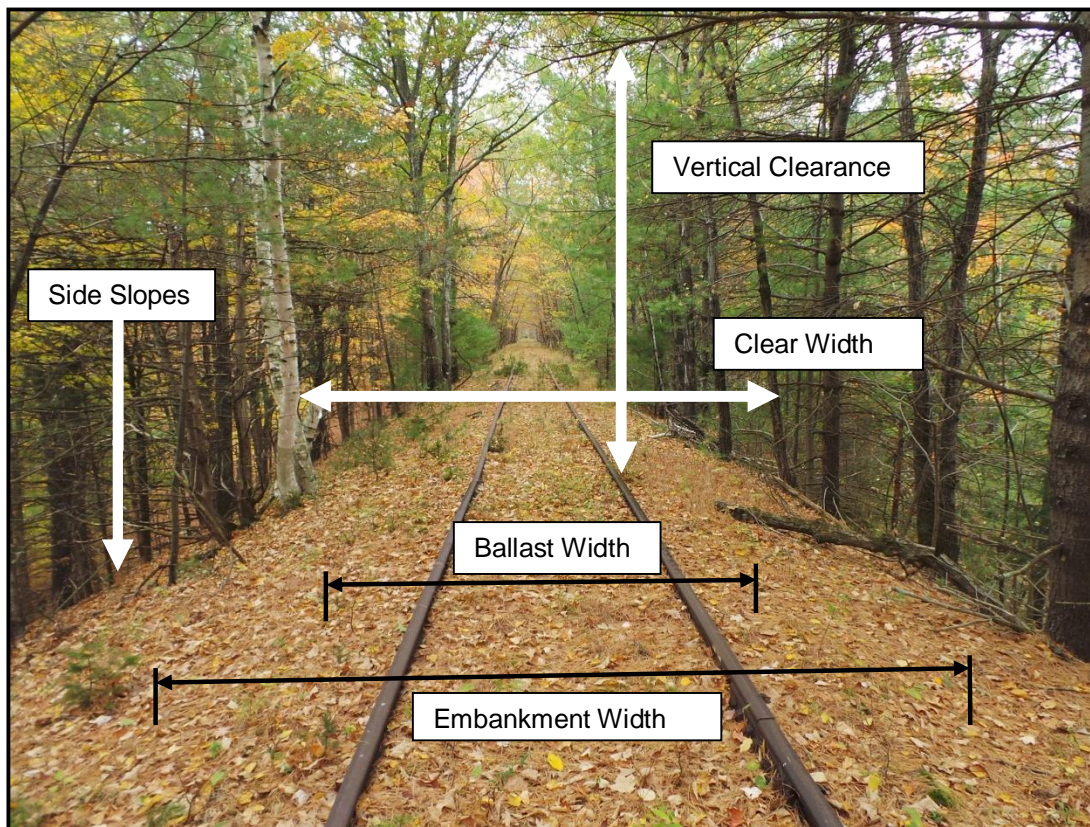

**Figure 5 – Example of Typical Corridor Dimensions**

Side Slopes: The side slopes through the segment varied from 5 feet to 30 feet in height, terminating into either a valley (shown in Figure 5) or a rock cut section shown in Photo 1-4. The rock sections range from approximately 5 feet to approximately 40 feet in height. The side slopes generally sloped downward at a rate of 2 feet horizontal to 1 feet vertical (2:1). Depending on the final design chosen, the side slopes in this segment should not require any repairs with the exception of the two areas have experienced rock slides, located at station 603+75 and at station 672+00 (See Appendix A). These areas will likely require a geological assessment and might need designed stabilization to reduce the chance of future rock slides.



**Photo 1-4 – Rock Cut Section**

Appendix B includes additional photos (122, 105-107 and 117-119) that depict the typical side slope conditions found throughout this segment.

Drainage: Storm drainage throughout the corridor was/is conveyed by concrete and steel culverts and drainage swales that run parallel to the railroad tracks. The drainage culverts were rated on a scale of 1-5, with 5 meaning the culvert is severely deteriorated and requires significant repair or replacement, and 1 meaning the culvert will need little to no repairs. There are nine (9) drainage culverts located in Segment 1 with seven (7) of those rated 3 or better. These will only require moderate to minor repairs.



**Photo 1-5**  
Rock Slide in Segment 1

The remaining two (2) concrete culverts are in poor condition and will require major repair or full replacement to restore functionality. These include the culvert located at station 620+00 which will require significant repair to the headwall and to repair the separation of two sections. The other damaged culvert is located at station 647+75 where significant erosion and scour of the concrete bottom has compromised the integrity of the entire structure. These large culverts are approximately 8 feet tall by 8 feet wide. The drainage ditches/swales are generally still discernible and will require some minor excavation and debris removal to restore flow and capacity. The two (2) separate culverts shown below exhibit significantly different internal conditions.



**Photo 1-6**  
Separation and Structural Damage Inside Culvert  
RR Tracks Directly above Damaged Section



**Photo 1-7**  
Only Minor Restoration and Maintenance  
Required Internally

Included in Appendix B are additional photos (109-113, and 123-124) that exemplify the drainage characteristics throughout this segment.

Trail Access Locations: Within this corridor segment, there is at least one location that provides an opportunity for trail access and parking. Located adjacent to the Woodstock Dike (See aerial image and inset below), just north of the railroad right-of-way, is an existing gravel area used for parking for

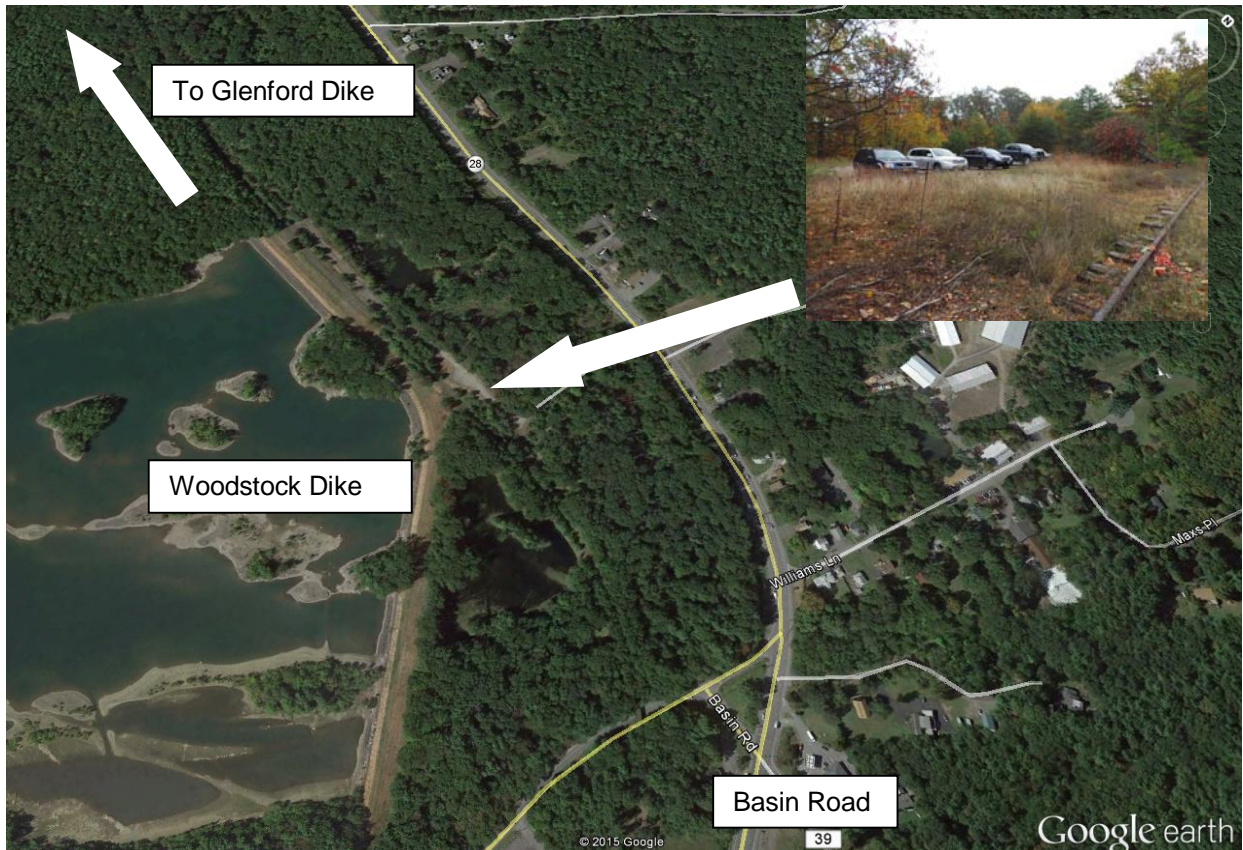

fishing and hunting access. This location is one of the logical starting points for potential trail users since it is approximately five miles from NYS Thruway Interchange 19 and the City of Kingston, and it is immediately adjacent to and accessed via NYS Route 28. A parking area in this location also provides easy access to views of the Ashokan Reservoir from the adjacent 10 feet high dike, known as the Woodstock Dike. An intersection and sight distance analysis is recommended to be included in detailed design phase should this location be progressed as a proposed access point.

As per the Agreement Ulster County and NYCDEP, the final location of trail access points or “trailheads” will be examined further during the public planning process.

Scenic Overlook Locations: This segment of trail provides the opportunity for at least two scenic overlooks of the Ashokan Reservoir. One of these locations is at the top of the Woodstock Dike which is near the existing gravel parking area mentioned in the trail access section. Another location for a scenic overlook is at the top of the Glenford Dike. The existing tracks traverse the top of this Dike making it a natural location for a scenic overlook. (See photo 1-8).

**Photo 1-8 – View from top of the Glenford Dike**



Stone Retaining Walls / Rock Outcrops: No stone retaining walls were present in this section of the U&D corridor. Rock outcrops were present throughout the segment and would form an approximately 40 feet wide channel in which the tracks, ballast, and drainage ditches are located. These rock outcrops were located on both sides of the railroad bed through cut sections and range in height between 5 feet and 45 feet. Two unstable sections of the rock outcrop walls were noted due to apparent minor rock slides at these locations. These rock slides are located approximately at station 603+85 and at station 671+85 (See Photo 1-5 above in the Side Slopes discussion). Material from the rock slides has filled in the drainage swales in these areas. Located in Appendix B are Photos (106, 108 and 122) which depict the general conditions of the rock cuts and the rock slides.

Unique features: In addition to the features mentioned above, this segment features a 3 feet high rock wall known locally as “the Chinese Wall.” The Wall is offset approximately 14 feet from the southern steel rail and traverses the Glenford Dike as shown below in photos 1-9 A and B. This 2,800 feet long wall appears to have been constructed close to, or at, the same time that the railroad infrastructure was moved from near the bed of the Esopus Creek to allow the construction of the Ashokan Reservoir in this area in the early 1900’s.

**Photos 1-9 A and B**  
Hand built Rock Wall  
a.k.a. “the Chinese Wall”



**Central Section (Segment 2)**

This segment of the corridor extends from approximately milepost K14 to milepost K18 (station 739+80 to station 950+80) for a length of 21,100 feet. It consists of earth cut slopes, fill slopes, and areas that are generally flat. For portions of the segment, NYS Route 28 is visible from the trail.

Railroad Infrastructure: The railroad infrastructure in this segment consists of steel rails, wooden ties, concrete signal foundations and stone ballast.

With the exception of one location, a 3 feet wide by 3 feet long by 1 feet deep sinkhole, the ballast throughout this segment remains intact. The steel rails remain barely fastened to the deteriorated wooden ties. In the lower lying areas of Segment 2, what remains of the wooden ties



**Photo 2-1**  
Ballast Loss and Severely Rotted Ties

are rotted remnants. Other railroad infrastructure noticed through this segment is a small building in disrepair that was reportedly moved to the site several decades ago, approximately located at station 860+50 on the plans in Appendix A. Including along this section are rail cars on the existing tracks.



**Photos 2-2 and 2-3 – Rail Cars in Segment 2**

Vegetation: This segment is generally clear of vegetation that would require removal except for the following two locations; from station 867+50 to station 868+50 and from station 869+00 to 881+00. Removal of pine trees under 10 feet tall will be required through these sections. The remainder of the segment exhibits grass and other light ground cover within the right-of-way. Additional tree removal and pruning may be required on the embankment of the segment depending on the alternative chosen. Tree removal will be required at the various locations where trees have fallen throughout the segment. Potential wetland conditions were observed from station 885+00 to station 893+00. This area will require further investigation and measures to avoid the wetland and its associated habitats will be applied during final design. Additional photos (208 and 209) are included in Appendix B which depict additional areas found within this segment that will require tree removal.

Corridor Dimensions: This segment exhibits varying characteristics throughout. The stone ballast varies from 8 feet - 20 feet in width. The clear width ranged from 10 feet – 32 feet and the embankment width ranged from 12 feet – 32 feet. Minor clearing will be required to provide the desired clear width. Overhead clearance was generally good with only minor pruning required to provide the desired vertical clearance.

Side slopes: Side slopes throughout this segment varied between 40 foot tall embankments that terminated into valleys, to earth cut slopes approximately 45 feet high land adjacent to the railroad corridor. This segment, although primarily comprised of steep slopes also exhibited isolated areas that were relatively flat. In this segment, most of the trail will likely require the installation of a pedestrian/bicycle barrier to shield users from the high and steep slopes. The flattening of slopes by adding material is a form of mitigation that can reduce raiiling installation. In locations with easy access, this is often more desirable than installing railing, however, given the remoteness of these locations, trucking in material could prove more costly both environmentally and fiscally. These and other options should be investigated and developed in greater detail during the design and public input process.



**Photo 2-4**  
Tall and Steep Side Slopes in Segment 2



Please refer to Appendix B for additional photos (201-204) that provide additional examples of the typical side slope conditions found throughout Segment 2.

**Drainage:** Drainage through this segment is collected and conveyed through cast iron culvert pipes, concrete culverts, drainage ditches, and swales. In general, these drainage methods appear to be functioning adequately. Very few areas of standing water or washouts exist throughout the segment. However, the majority of the drainage ditches will need some degree of clearing, which includes, but is not limited to, leaf and debris removal, brush removal, and tree removal. Overall, the six concrete culverts in this segment were functioning adequately and will require only minor repairs. The eight (8) one- to two- foot diameter cast iron culvert pipes in this section will require repair or adjustment to improve their alignments. Over time the pipe sections have settled irregularly and either sag in the middle or have sections that have become separated. This differential settlement and separation has resulted in minor to major erosion most notably at station 832+00 where the ballast and earth below the rails is washed out to a depth of approximately 2 feet.

Pipe material, whether steel or concrete, is in good condition throughout the segment and with some adjustments can be reused to accommodate future drainage needs. Other typical drainage needs include debris removal from the culverts, removal of trees and debris from swales, and minor repairs to the concrete culverts. Photos 2-5 and 2-6 below depict the general conditions of the headwalls and culverts found throughout Segment 2.



**Photos 2-5 and 2-6**

Minor and Major Culvert Headwalls in Good Overall Condition – Segment 2

**Trail Access Locations:** This segment of corridor includes one and possibly two readily accessible opportunities for potential trailhead locations. The first area on the eastern end is located approximately halfway between Basin Road and Boiceville near milepost K 16¼ or Station 857+00 on the plans in Appendix A. This area is accessed from NYS Route 28 via a gravel roadway which crosses the railroad tracks and then opens up to a large clear area approximately 120 feet wide and 500 feet long. The area is relatively flat and would allow for easy trail access and parking. From this area, a gravel roadway extends eastward and connects to “Jones Cove” (See Aerial Photo and Inset above). The second potential trail access area is located just west of the Reservoir Road overpass.

This area would be easily accessed by motor vehicle through a clearing located just off Reservoir Road that could serve as a parking area. As per the Agreement between Ulster County and NYCDEP, the final location of trail access points or “trailheads” will be examined further during the public planning process.

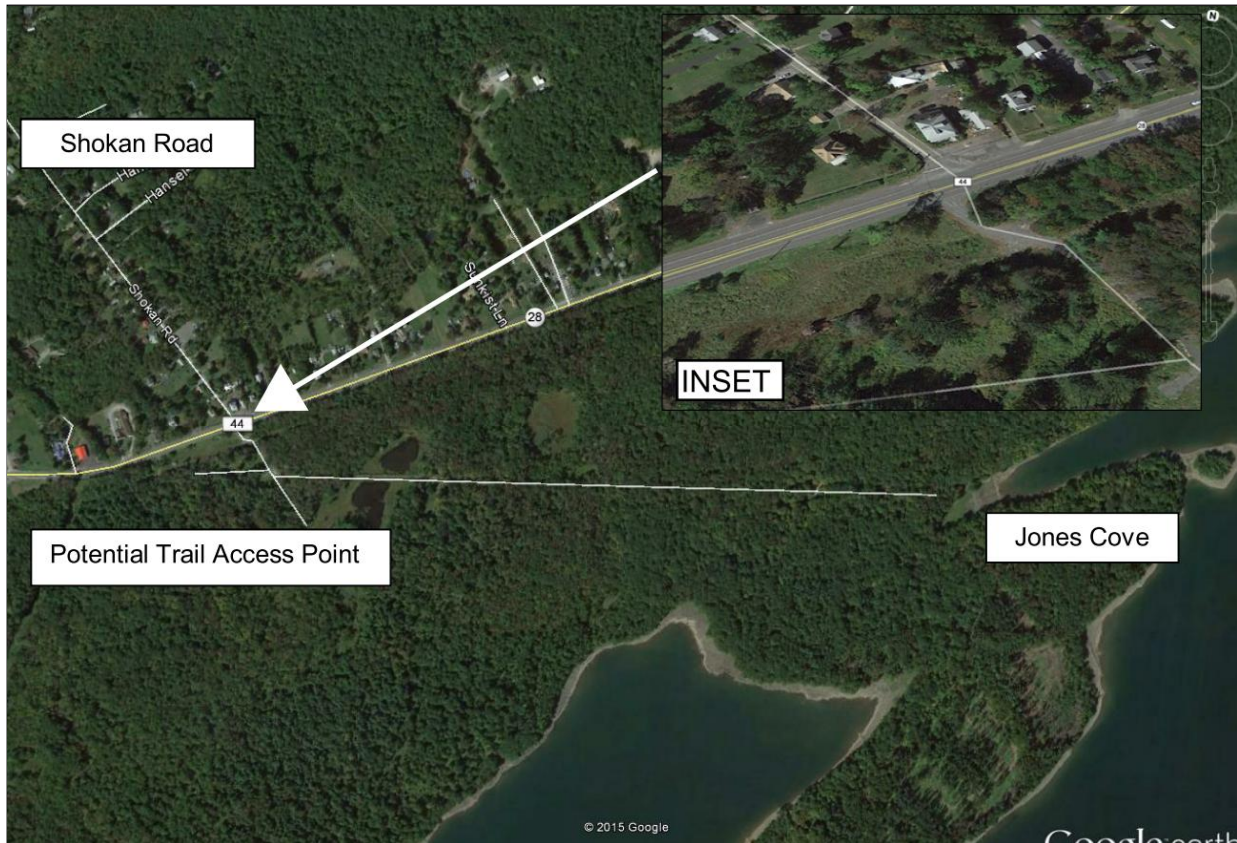

Scenic Overlook Locations: There are no readily apparent scenic overlooks within this segment. The segment traverses primarily through woodlands.

Stone Retaining Walls / Rock Outcrops: This segment does not contain any rock outcrops or stone retaining walls.

Unique features: This segment of trail traversed through woodlands that feature existing stone walls laid out throughout the woods outside of the railroad right-of-way. A photo of the wall can be found in Appendix B (photo 217).

**Butternut Cove (Segment 3)** – This segment extends approximately from milepost K18 (station 950+80) to milepost K19 (station 1003+00). This segment features two contrasting types of side slopes and a major washout of the railroad embankment, known as the Butternut Cove washout. A detailed report of the Butternut Cove washout was developed by B&L and is included in Appendix E.

Railroad Infrastructure: The remaining railroad infrastructure in this segment consists of steel rails, wooden ties, concrete signal foundations and stone ballast. Existing steel rails remain attached in most areas to wooden ties. These wooden ties are in poor condition and exhibit significant deterioration. This is most apparent where stormwater flows in close proximity to the ties and the roadbed is saturated. The stone ballast is eroded in two locations through this segment, leaving the rails unsupported (See Photo 3-1 and additional photos in Appendix B).



**Photo 3-1 - Severe Deterioration in Segment 3**

Vegetation: Vegetation requiring removal within the railroad right-of-way throughout the segment is minimal, especially in the section east of the Butternut Cove washout. West of the washout, vegetation consisting of low brush, small trees, and weed overgrowth exists within the right-of-way and will require removal. Various overhead tree limbs will require pruning to provide for acceptable overhead clearance. Fallen trees were noted throughout the corridor and will need to be removed. A photo (302) located in Appendix B depicts general vegetation characteristics of this segment.

Corridor Dimensions: This segment exhibited generally consistent conditions throughout. Stone ballast ranged in width from 9 feet – 12 feet. Clear Width ranged from 13 feet – 25 feet, and the embankment width ranged from 18 feet – 29 feet. Minor clearing of trees may be required to improve trail safety and meet the recommended Clear Width requirements.

Side slopes: Segment 3 primarily exhibits of two types of side slopes: earth cut and earth fill sections. Earth cut sections are approximately 20 feet high on both sides of the railroad right-of-way which then transition to steep fill section with steep side slopes that are approximately 20 feet high. Areas of embankment have progressively eroded over time. The shape and construction of the side slopes are generally consistent with the photos of Segments 1 and 2, however, photos 303 through 306 in Appendix B can be viewed for a more detailed view of segment 3 slope conditions.

Drainage: Overall the conveyance and runoff characteristics are similar

to other segments of the corridor. Within the cut sections, runoff flows into the valleys created by the railroad infrastructure and is collected in drainage swales and conveyed towards Butternut Creek. Some of the side slopes leading into the drainage ditches have experienced minor to moderate erosion and can be restored with careful grading and stabilization. Located at station 980+75, is a concrete culvert that conveys Butternut Creek under the railroad and into Butternut Cove. The culvert is heavily damaged on the downstream side and will require replacement. The culvert has

sustained a long period of deterioration beginning in the 1980's to the present day. The separation and collapse of the culvert wingwalls, has caused a major portion of the railroad embankment to also collapse. It appears that the material originally retained by the culvert wingwalls has eroded into the creek. A detailed investigation, report, and the estimated replacement costs for the Butternut Cove Culvert has been prepared by Barton & Loguidice and is included in Appendix E.

**Photo 3-2  
Butternut Cove Culvert Southern Face**



**Photo 3-3  
Loss of Embankment, Ballast and Ties adjacent to the  
Butternut Cove Culvert**

Additional photos (308 through 311) in Appendix B can be viewed to illustrate the deterioration of the railroad infrastructure adjacent to the Butternut Cove Culvert.



Trail Access Locations: Trail access to this area could be provided by a NYC Department of Environmental Protection trail, which extends

from a gated access along Longyear Road that leads to the railroad right-of-way. This road is a narrow unimproved road that would require stabilized base and surface improvements to be used as a trail access road. Without improvements it is not recommended to be a major trail access point. This area could be assessed as a local access point limited to pedestrians and bicyclists (no parking facilities).

Scenic Overlook Locations: The Ashokan Reservoir is visible through the trees while traversing the fill section of the segment; however, no scenic overlook areas were readily identifiable due to the need for extensive tree clearing.

Stone Retaining Walls / Rock Outcrops: This segment does not contain any rock outcrops or stone retaining walls.

Unique features: In addition to the Butternut Creek washout, another section that appears to have been washed out is located west of Butternut Creek. The rails at this location are elevated approximately 3 feet above the ground for 100 feet at station beginning at Station 989+00 by way of stacking wooden ties on top of each other to support the rails (“cribbing”).



**Photo 3-4 – “Cribbing” of the rails**

**Western Shore (Segment 4)** – This segment extends approximately from milepost K19 (station 1003+00) to the Esopus Creek and the Boiceville Trestle, approximately milepost K21¼ (station 1122+50). This segment generally consists of a cut slope, which is part of a hillside, north of the corridor and an embankment that slopes down to the Ashokan Reservoir to the south of the corridor.

Railroad Infrastructure: The remaining railroad infrastructure in this segment consists of steel rails, wooden ties, concrete signal foundations and stone ballast. The rails in this section remain loosely attached to wooden ties, the majority of which exhibit significant deterioration. Very few sections of wooden ties are in good condition. Erosion of the land adjacent to the railroad has led to three portions of this segment to become completely covered by earth. Please refer to Photos 401 through 403 located in Appendix B.

Vegetation: The majority of the segment exhibits dense, heavy brush and overgrowth on the rail bed and adjacent right-of-way. In addition to the heavy brush, numerous trees have fallen directly onto and adjacent to the tracks and will require removal prior to construction of a trail. This segment is essentially cut off from the eastern track sections due to the Butternut Creek Culvert washout at the

eastern end of the segment and the collapse of the Boiceville Trestle at the western end of the segment. Dense vegetation conditions are present throughout the segment.

**Corridor Dimensions:** This segment exhibited variable dimensions throughout. Stone ballast varies from 9 feet – 12 feet in width. Clear Width varies from 23 feet – 52 feet and the embankment width varies from 13 feet – 52 feet in width. Clearing of various trees will be required to improve trail safety and maintain the recommended Clear Width. Overhead clearance is generally adequate, however, isolated sections will require pruning to establish desired vertical clearance.

**Side slopes:** The side slopes throughout the segment were generally consistent. The southern side of the right-of-way borders the Ashokan Reservoir for the majority of the segment. The slope consists primarily of rip-rap below the high water line and loose stone and earth above the high water line. The north side of the corridor is a cut section that slopes upward. This hillside is relatively steep and has many various drainage deficiencies. Two separate portions of the segment have fill slopes on both sides of the tracks which lead to the reservoir. These sections could be classified as causeways, with the main reservoir on the south side of the tracks and ponds on the north side. Other side slope conditions throughout this segment display characteristics found throughout the other segments of the rail corridor such as fill slopes and cut slopes on both sides of the tracks.

Overall the side slopes appear to be stable with one notable exception, shown below in photo 4-1, where the embankment has eroded away presumably into the Ashokan Reservoir, leaving the edges of the wooden ties suspended in the air for an approximately 50 feet long section. This is located at station 1023+50.



**Photo 4-1**

Erosion of Ballast and Embankment. Slope Stabilization design will be required in these areas

Additional photos (408 through 412) in Appendix B represent the various side slope conditions found throughout this segment.

**Drainage:** The drainage conditions are poor through the majority of the segment. Erosion of the northern hillside and ballast below the tracks is present in many locations and has caused significant damage to the railroad infrastructure throughout this segment. Of the 10 drainage structures located within this segment, seven were steel/iron pipes and three were concrete structures. Four of the steel/iron pipes require repair and two of the concrete arches require repair. Typical damage to the steel/iron pipes included differential settlement of the pipe sections and blockages caused by erosion of the inlet side of the pipe. Erosion of the area downstream of the pipes was also noted. Evidence of high velocity flows are present. Photos (414 through 425) in Appendix B depict the drainage characteristics throughout this segment.

**Trail Access Locations:** This segment of trail does not contain readily accessible trailhead locations or parking areas. The steep terrain between the rail segment and NYS Route 28 does not appear to provide any reasonably feasible areas for access. The western end of this section is approximately 0.25 miles from NYS Route 28A.

**Scenic Overlook Locations:** This segment has multiple scenic overlook locations due to the proximity of the Reservoir to the corridor. Panoramic views of the Catskill Mountains and Ashokan Reservoir are abundant once the leaves have fallen from the trees. There are opportunities for all-year-round

viewing utilizing vistas (see Photo 4-2) and with select tree trimming. Photos (426 and 427) in Appendix B show unobstructed and potentially obstructed (in the summer) views of the Ashokan reservoir.

Stone Retaining Walls / Rock Outcrops: This segment does not contain any rock outcrops or stone retaining walls.

Unique features: This section of trail traverses along the northern shore of the Ashokan Reservoir and provides significant scenic views of the water and surrounding

Catskill Mountains. Also unique to this segment are two manmade ponds located north of the railroad

embankment. The water elevations in the ponds are subject to the fluctuations of the Ashokan Reservoir. The close proximity of the ponds and the reservoir to the tracks makes for a unique area when compared to the woodland areas of the rest of the rail corridor.



**Photo 4-2**  
**Potential Vista and Scenic Overlook in Segment 4**

**Boiceville Trestle Segment (Segment 5)** – This segment stretches between the destroyed Boiceville Railroad Trestle at milepost K21¼ (station 1125+75) and the NYS Route 28A overpass (station 1139+50). A detailed assessment of the Boiceville Railroad Trestle was conducted and prepared by Barton & Loguidice and is included in Appendix D.

**Photo 5-1**  
**Portion of the Remains of the Boiceville Trestle**

Railroad Infrastructure: The remaining railroad infrastructure in this segment consists of steel rails, wooden ties, concrete signal foundations, stone ballast and the remains of a railroad trestle. The steel rails in this section remain loosely attached to the wooden ties, which are in poor condition. The

Boiceville Railroad Trestle previously spanned 294 feet across the Esopus Creek. During Hurricane Irene and Tropical Storm Lee, which brought heavy rains to the area, flood waters of the Esopus Creek destroyed most sections of the Boiceville Trestle. Only one of the four sections of the trestle remains in place. Photo 5-2 below shows another view of the remains of the Boiceville Railroad Trestle. Replacement of the structure with some type of crossing will be necessary to make the connection to NYS Route 28A.



**Photo 5-2** – In the background, remnants of the Boiceville Railroad Trestle over the Esopus Creek



Additional photos (502 through 505) can be found in Appendix B that depict the existing conditions of the Boiceville Trestle.

Vegetation: Existing vegetation in this segment is not overgrown and does not encroach on the existing railroad corridor. This segment will not require significant tree clearing or brush removal.

Corridor Dimensions: This segment exhibited varying conditions throughout. Stone ballast ranged from 8 feet – 15 feet in width. Clear Width varies from 22 feet - 26 feet and the embankment width varies from 8 feet – 15 feet wide. These dimensions are ideal and will require minimal construction efforts to complete the recreational trail.

Side slopes: The approximately 500 feet of the segment adjacent to the Esopus Creek consists of side slopes that slope down approximately 8 feet on both sides of the railroad right-of-way. From here the terrain transitions to generally level with drainage ditches located on both sides of the railroad right-of-way. Photos (506 and 507) in Appendix B show the general side slope characteristics found throughout the segment.

Drainage: The drainage ditches in this segment are poorly defined, very shallow, and contain debris. There are only two drainage pipes and one stone box culvert, all of which are not functioning and are in need of repair. Photos (507 and 508) in Appendix B show the existing drainage conditions found in segment 5.

Trail Access Locations: This segment currently contains a small access parking lot that is predominantly utilized by fisherman with permits to use the Esopus Creek. An existing footpath connects the parking lot and the railroad embankment. Expansion of the parking area onto NYCDEP property should be explored as it to improve safety and to provide increased capacity for parking.

Scenic Overlook Locations: Once completed, a crossing of the Esopus Creek where the Boiceville Trestle once stood could provide unique scenic views of the Esopus Creek and the Catskill Mountains. The development of a new crossing can be viewed as an opportunity for enhanced access to the available scenic viewsheds.

Stone Retaining Walls / Rock Outcrops: This segment does not contain any rock outcrops or stone retaining walls.

Unique features: This segment does not contain any unique features.

## CHAPTER 3 – PROPOSED ALTERNATIVE

This chapter discusses the alternatives considered and examines the engineering aspects for all feasible alternatives to address project objectives identified in Chapter 1 of this report.

The proposed Ashokan Rail Trail will follow the former rail bed and will begin at the Basin Road overpass with an access point potentially located at station 541+00 which is approximately 0.25 miles west of the Basin Road overpass. Alternate access points will also be investigated during the public involvement and design phase of the project. The trail will continue approximately 11.5 miles west through NYC DEP land adjacent to the Ashokan Reservoir to the western access point, located at the NYS Route 28A overpass at approximately station 1135+00. The trail is expected to include a replacement bridge spanning the Esopus Creek at the site of the former Boiceville Railroad Trestle and reconstructed embankments and culvert at Butternut Cove. The NYCDEP has indicated that the rails and ties must be removed from the corridor. The method and means of removal is currently being investigated and will be determined during final design. Based on the feasibility study of the corridor, most of the existing stone ballast can be reused as part of the trail structure. This will help to reduce overall project costs due by reducing the volume of material and the distance the material would need to be transported. New subbase stone will be required in some areas to supplement, replace, restore, and repair the existing ballast and subgrade. The trail surface treatment is currently being investigated and will be determined during final design. Bicycle and pedestrian railing will need to be installed at certain locations to shield users from the steep side slopes. Drainage improvements will need to be made to the corridor, including existing culvert repair, new culvert installation, drainage swale restoration and the implementation of environmentally sound stormwater management practices. The multi-use trail would extend 11.5 miles through woodland areas with significant scenic vistas of the Ashokan Reservoir and Catskill Mountains anchoring the east and west ends of the proposed trail.

Design standards have been established to create typical sections of the proposed trail and to aid in the feasibility determinations developed as part of this study. These typical sections were applied to the trail corridor based on the existing conditions, constraints, objectives of the project and with special attention to environmental stewardship along the entire corridor. The typical sections were used to determine approximate construction cost estimates for each segment. Construction cost estimates for each segment are shown later in this chapter. Additional information utilized to assist in determining estimated construction costs are included in Appendix C.

The design standards utilized for the project follow the *AASHTO Guide for the Development of Bicycle Facilities 2012* and the *New York State Department of Transportation Highway Design Manual*. Design standards for the project used to determine feasibility, impacts, constraints, and to assign estimated construction costs can be viewed in the table below:



Figure 5 - Catskill Mountain Rail Trail - Ashokan Section Multi-Use Facility Design Criteria			
Element		Standard	Proposed
A.	Minimum Design Speed	18 MPH	20 MPH
B.	Multi-use Trail Width: Minimum Recommended	10.0 feet* 10.0 feet to 14.0 feet	12.0 feet
C.	Multi-use Trail Shoulder Width Slope of 1V:6H	2.0 feet (min), 3.0 feet to 5.0 feet (ideal range) 5.0 feet	5.0 feet
	Slope of 1V:3H		5.0 feet
D.	Distance between edge of trail and top of slope without barrier	5.0 feet	5.0 feet
E.	Maximum Grade	5%	1.0%
F.	Minimum Horizontal Radius	120 feet	> 120 feet
G.	Design Cross Slope: Minimum	1.0% 2.0%	2.0%
	Maximum		
H.	Stopping Sight Distance	300 feet	> 300 feet
I.	Minimum Lateral Clearance w/ barrier	1.0 feet 2.0 feet	2.0 feet
	w/ post mounted signs		2.0 feet
J.	Minimum Vertical Clearance (bridges & tunnels) Recommended Min.	8.0 feet 10.0 feet	10 feet
	Desirable		
K.	Bridge Structure Capacity (rail)	Cooper E-80	Cooper E-80
L.	Minimum Rail Height	42 in. to 48 in.	48 in.
M.	Signage	MUTCD and the NYS Supplement to the MUTCD	MUTCD and the NYS Supplement to the MUTCD
N.	Pedestrian Accommodations	HDM Ch. 18 & ADAAG	HDM Ch. 18 & ADAAG

*\*Design standard established is a 10'-0" width; however 8'-0" may be adequate in areas of limited physical width or other obstructions.*

Additional design criteria to be applied to the trail are as follows:

- Design Storm for open drainage systems is the 10 year storm. Trail cross culverts will be designed for the 50 year storm. The Butternut Cove Culvert and Esopus crossing will require specific hydraulic analyses where typically 50 to 100 year storm designs are accommodated. However, providing additional capacity beyond the 100 year storm will be discussed during the initial design phase of the project.

- Safety rail will be included adjacent to the trail when a clear area of 5 feet at a maximum slope of 1:6 cannot be achieved and one of the following conditions are present:
  - Slope is equal to or steeper than 1:3 for a vertical drop greater than 6 feet
  - Slope is equal to or steeper than 1:2 for a vertical drop greater than 4 feet
  - Slope is equal to or steeper than 1:1 for a vertical drop greater than 1 foot
  - Slope is equal to or steeper than 1:3 adjacent to a parallel body of water or other substantial obstacle.
- The design clear zone width for the corridor will be a minimum of 5 feet. Upon completion of the construction of the trail, the design clear zone width will be measured from the edge of trail to the nearest obstacle. In areas where the desirable clear zone cannot be achieved, safety rail may be installed to shield pedestrians and bicyclists.

Using the established design criteria shown in Exhibit 3.1, typical sections have been established and applied throughout the corridor based on existing conditions of the corridor and constraining elements in each section, such as adjacent rock walls or steep embankment slopes. The typical sections have been applied and adapted to best suit the land adjacent to the proposed trail

Figure 6 is a conceptual typical section illustrating a 12 feet wide trail with 5 feet wide shoulders consisting of compacted earth or trail material. The side slope conditions beyond the shoulders vary based on the adjacent topography of the land. This section is applied in locations where the adjacent land is relatively flat or there are no obstacles that would pose a safety risk to users that accidentally leave the defined trail.

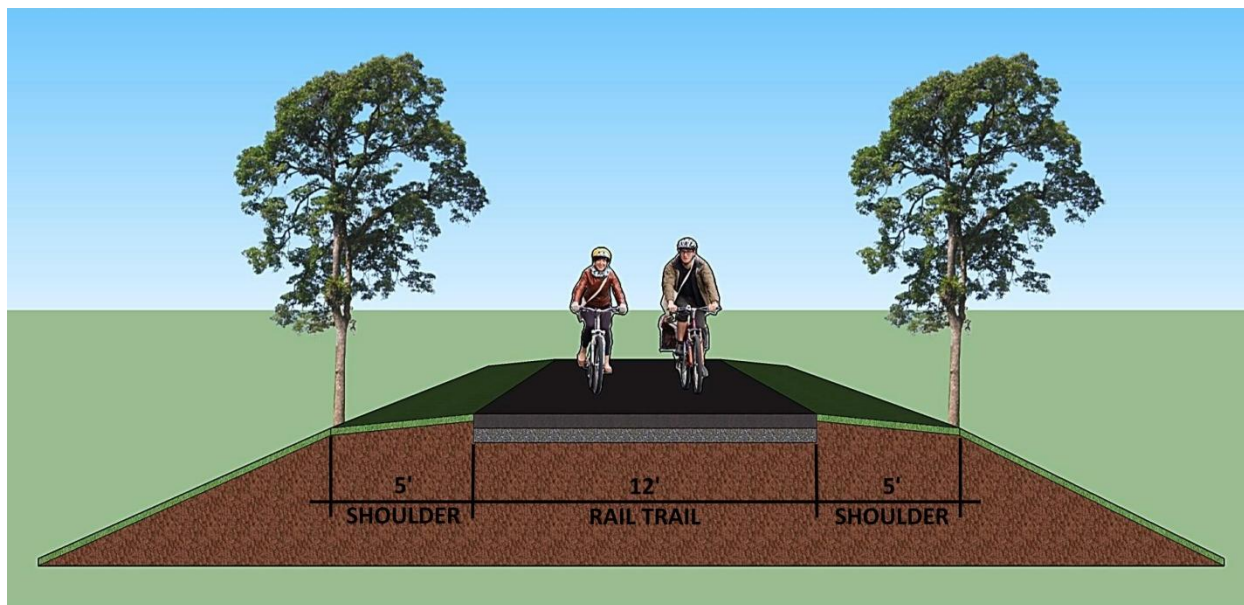

**Figure 6 – Typical Section A**  
(Standard Rail Trail Section)

Figure 7 is a conceptual typical section illustrating the proposed trail with narrow 2 feet wide shoulders and pedestrian guiderail. This typical section will be employed in areas of steep embankments that do not provide the minimum 5 feet shoulder width and/or areas adjacent to dangerous obstacles such as a body of water. This guiderail will measure 48 in. in height and will consist of three horizontal wooden rails. This guiderail will be installed 2 feet from the edge of the 12 feet wide trail.

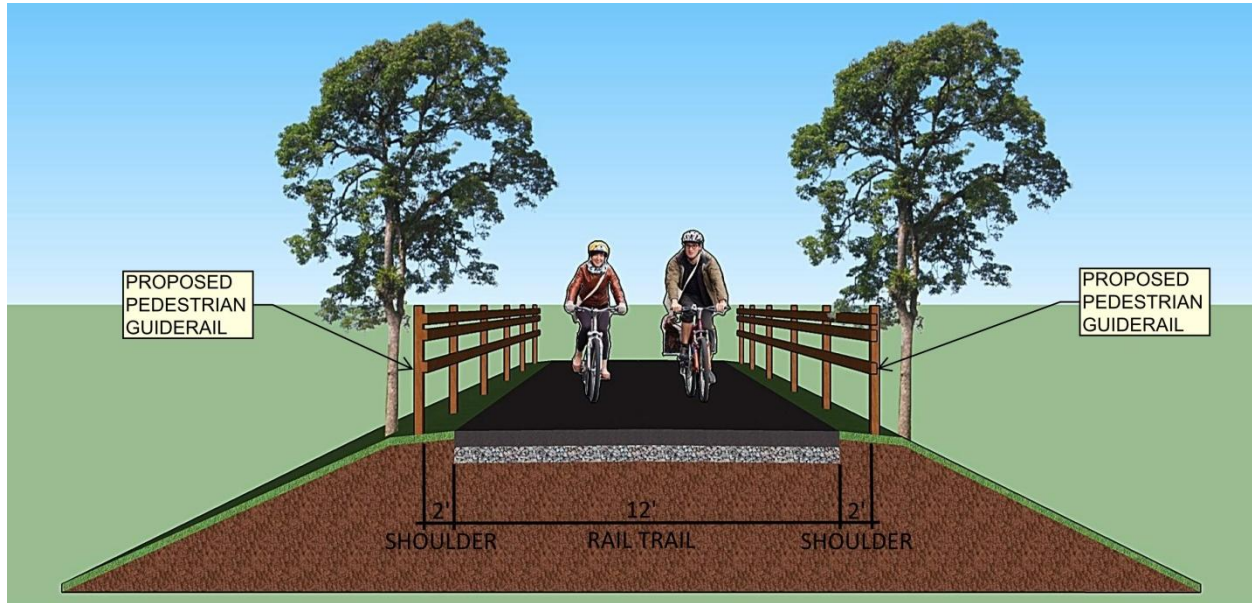

**Figure 7 – Typical Section B**  
(Rail Trail with Guiderail)

Figure 8 is a conceptual typical section that requires the shoulder width to be reduced but does not require the installation of pedestrian guiderail. In these areas rock walls or deep earthen cut sections typically flank both sides of the trail. The shoulder widths have been reduced to 2 feet in width in order to maintain a 12 feet wide trail and to provide enough width for drainage improvements. In these areas it is not cost effective to remove large volumes of material allowing for shoulder width expansion.

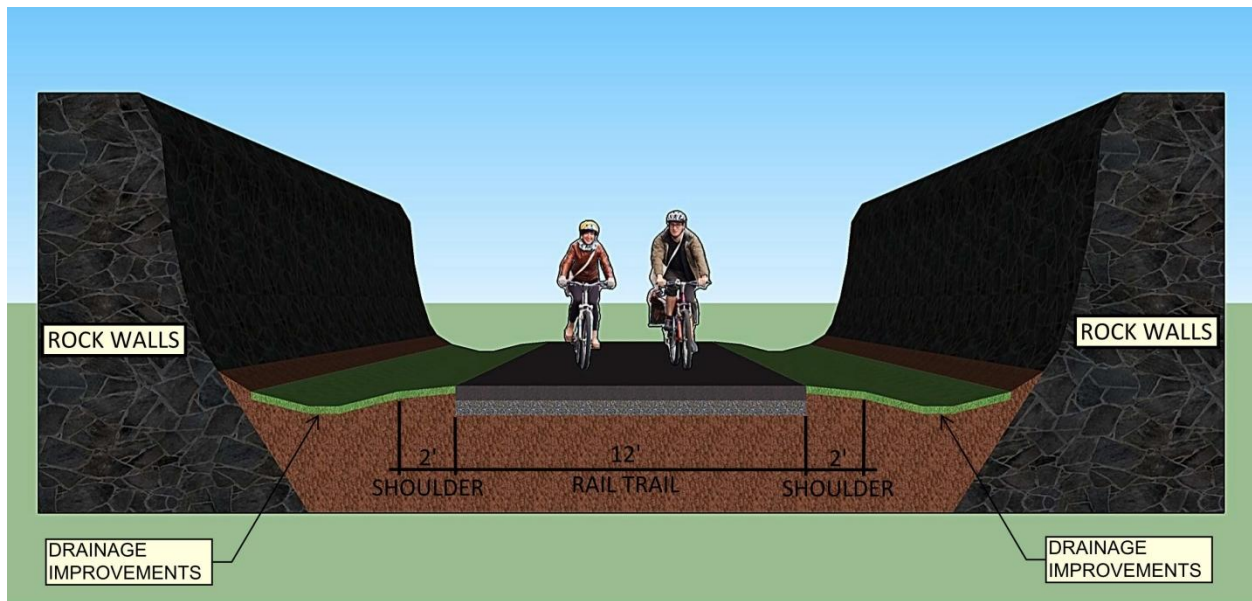

**Figure 8 – Typical Section C**  
(Narrow Shoulder Section)

Figure 9 is a conceptual typical section that is a hybrid of Typical Sections A and B. Throughout the trail corridor, some areas only require guiderail to be constructed on one side of the trail. Also, in some areas a lateral shift of the trail alignment one way or the other will allow a standard 5 feet shoulder to be installed, thereby, reducing cost for additional pedestrian guiderail. This condition is displayed in the following graphic:

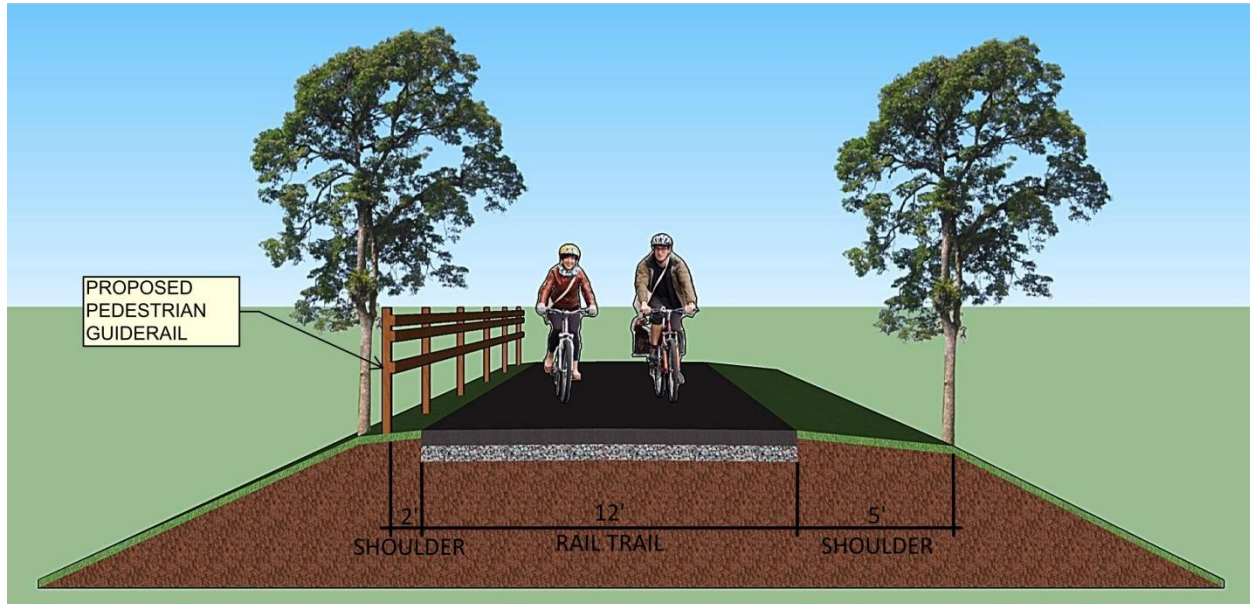

**Figure 9 – Typical Section D**  
(Guiderail and Standard Shoulder)

Alternatives Considered: Two alternatives were considered when selecting the typical sections to match the existing conditions found throughout the corridor. Alternative 1A consists of applying typical sections A through D and maintaining the existing grade as much as possible in order to reduce the amount of excavation or grading required. The location of the corridor is adjacent to the Ashokan Reservoir, which supplies New York City's drinking water and is protected and maintained by DEP, suggests that excavation material will need to be disposed of offsite. This could lead to increased construction costs due to the rural nature of some sections of the corridor. However, the installation of guiderail is also costly. In order to attempt to balance the need to reduce the amount of guiderail that would be necessary to build Alternative 1A, a second option was developed that would reduce the amount of guiderail to be installed by lowering the profile to create a wider area on top of the embankment allowing Typical Section A to be utilized rather than the more costly Typical Section B.

Cost Estimates: Construction cost estimates were developed to compare the approximate costs of constructing the two previously mentioned alternatives. These cost estimates took into account the topography of the land and the existing conditions of the vegetation, drainage conditions, embankment conditions, and the proposed material costs. Additional costs may be required based on the proposed trail impacts to existing conditions that will be investigated during final design of the trail design. Figures 10 and 11 show the estimated costs associated with each alternative assuming that the top surface is stone dust. The following cost estimates also displays the total construction costs based on constructing the eastern half (milepost K10 to K16¼) of the corridor and the western half (milepost K16¼ to K21½) of the corridor. Milepost K16¼ represents the location of the potential midpoint trailhead at Jones Cove.

<b>Figure 10 Option 1A Construction Project Costs</b>						
<b>Activities</b>	<b>Segment 1</b>	<b>Segment 2A</b>	<b>Segment 2B</b>	<b>Segment 3</b>	<b>Segment 4</b>	<b>Segment 5</b>
Trail Construction Costs*	\$868,571	\$485,377	\$297,323	\$134,572	\$347,311	\$72,255
Clearing	\$24,000	\$15,000	\$2,000	\$2,000	\$69,000	\$1,000
Drainage	\$240,000	\$92,000	\$42,000	\$17,000	\$155,000	\$12,000
Trail Access Facility	-	-	-	-	-	-
Trail Access Adjustment (+/-10-15%)	\$86,857	\$48,538	\$29,732	\$13,457	\$52,097	\$7,225
<b>Total Construction Cost</b>	<b>\$1,219,428</b>	<b>\$640,915</b>	<b>\$371,055</b>	<b>\$167,029</b>	<b>\$623,407</b>	<b>\$92,480</b>
Survey (+/- 2%)	\$24,389	\$12,818	\$7,421	\$3,341	\$12,468	\$1,850
Contingency (+/- 10%)	\$121,943	\$64,092	\$37,105	\$16,703	\$62,341	\$9,248
Field Change Payment (5%)	\$60,971	\$32,046	\$18,553	\$8,351	\$31,170	\$4,624
Mobilization (5%)	\$60,971	\$32,046	\$18,553	\$8,351	\$31,170	\$4,624
<b>Subtotal (2015 Dollars)</b>	<b>\$1,487,702</b>	<b>\$781,917</b>	<b>\$452,687</b>	<b>\$203,775</b>	<b>\$760,557</b>	<b>\$112,826</b>
Construction Inspection (10%)	\$149,000	\$79,000	\$46,000	\$21,000	\$77,000	\$12,000
<b>Total Project Costs per Segment</b>	<b>\$1,640,000</b>	<b>\$870,000</b>	<b>\$500,000</b>	<b>\$230,000</b>	<b>\$840,000</b>	<b>\$130,000</b>
<b>Total Project Costs Eastern Segments</b>	<b>\$2,510,000</b>		<b>-</b>			
<b>Total Project Costs Western Segment</b>	<b>-</b>		<b>\$1,700,000</b>			

\*Assumes stone dust as the surface treatment. A detailed breakdown of each segment and additional surface treatment materials and their associated costs are provided in Appendix C.

Figure 11 Option 1B Construction Project Costs						
Activities	Segment 1	Segment 2A	Segment 2B	Segment 3	Segment 4	Segment 5
Trail Construction Costs*	\$813,876	\$485,352	\$348,624	\$175,496	\$481,209	\$56,476
Clearing	\$31,000	\$18,000	\$2,000	\$3,100	\$69,000	\$1,000
Drainage	\$240,000	\$92,000	\$42,000	\$17,000	\$155,000	\$12,000
Trail Access Facility	-	-	-	-	-	-
Trail Access Adjustment (+/-10-15%)	\$81,388	\$48,535	\$34,862	\$17,550	\$72,181	\$5,648
<b>Total Construction Cost</b>	<b>\$1,166,263</b>	<b>\$643,887</b>	<b>\$427,486</b>	<b>\$213,146</b>	<b>\$777,390</b>	<b>\$75,124</b>
Survey (+/- 2%)	\$23,325	\$12,878	\$8,550	\$4,263	\$15,548	\$1,502
Contingency (+/- 10% @ Design Approval)	\$116,626	\$64,389	\$42,749	\$21,315	\$77,739	\$7,512
Field Change Payment (5%)	\$58,313	\$32,194	\$21,374	\$10,657	\$38,869	\$3,756
Mobilization (5%)	\$58,313	\$32,194	\$21,374	\$10,657	\$38,869	\$3,756
<b>Subtotal (2015 Dollars)</b>	<b>\$1,422,841</b>	<b>\$785,542</b>	<b>\$521,533</b>	<b>\$260,038</b>	<b>\$948,416</b>	<b>\$91,651</b>
Construction Inspection	\$143,000	\$79,000	\$53,000	\$27,000	\$95,000	\$10,000
<b>Total Project Costs per Segment</b>	<b>\$1,570,000</b>	<b>\$870,000</b>	<b>\$580,000</b>	<b>\$290,000</b>	<b>\$1,050,000</b>	<b>\$110,000</b>
<b>Total Project Costs Eastern Segments</b>	<b>\$2,440,000</b>		<b>-</b>			
<b>Total Project Costs Western Segments</b>	<b>-</b>		<b>\$2,030,000</b>			

\*Assumes stone dust as the surface treatment. A detailed breakdown of each segment and additional surface treatment materials and their associated costs are provided in Appendix C.

Trail Access Locations: Access to the trail corridor will be provided via dedicated vehicle parking areas and trailheads located at logical locations throughout the trail corridor. Access will also be provided at both the eastern and western terminus of the trail when the adjacent sections are constructed. Three locations were selected as potential vehicle access points along the corridor to provide direct access to the trail system. These locations are located at the eastern terminus, the approximate midpoint of the trail corridor, and the western terminus of the corridor. The eastern location is located at station 540+85. This area currently provides a flat, gravel parking area which is approximately 500 feet south of NYS Route 28 and would provide access to the eastern terminus of the corridor. The middle access location is approximately located at station 857+00. This area is located at the access point to “Jones Cove” and across Route 28 from Shokan Road. This area, at the time of the field data collection, consisted of old railroad equipment and a large a clear area which appears to be suitable for a trail access location and parking facilities. The western access point is approximately located at station 1134+50 via an unimproved NYC DEP roadway that connects the existing railroad tracks to a small gravel parking area located adjacent to NYS Route 28A. This parking area may need to be expanded in order to be developed as a trail access location. Sanitary facilities, kiosks, and appropriate signing will be provided at all three major trailheads and will coordinated with NYC DEP.

Drainage: Drainage throughout the corridor is mainly collected via drainage swales located adjacent to the existing railroad tracks and conveyed to steel and / or cast iron pipes or concrete culverts ranging from 1 foot in diameter to 10 feet in diameter. The pipes and culverts currently convey runoff from north

to south and eventually into the Ashokan Reservoir. Repair and replacement of approximately 60% of the the existing pipes and culverts will be required to enable the drainage systems to function properly.

Trail Materials: Recreational trail surface materials can vary from hard non-porous materials such as Portland Cement Concrete to porous materials such as stone dust or crushed aggregate. Hard surface materials are generally preferred over loose materials because they are more durable, have a longer service life and are preferred by bicyclists and other wheeled users due to the smooth and stable riding surface. Asphalt Cement Concrete and Portland Cement Concrete are the most common hard surface materials. Stone Dust, Crushed Aggregate, and Recycled Asphalt Millings are common loose surface treatments. Loose surface materials are typically subject to erosion during heavy rain events, which can lead to potholes and an uneven surface. Hard materials are resistant to erosion and can also be constructed to allow rain water to infiltrate through the pavement and into the soil below. These porous pavements have been used successfully on parking lots, sidewalks, and roadways to reduce the amount of stormwater runoff. Additional trail surface materials have been developed recently that use natural materials, such as pine pitch, to provide increased stability and erosion control when applied to loose materials. These products are typically applied via surface spray nozzle to stone dust or native soils and allowed to harden. The resulting surface is a firm, smooth surface that will resist erosion and transportation during storm events and will exhibit increased resistance to wear and tear from heavy pedestrian and bicyclist traffic when compared to conventional stone dust or soil. During the design phase, the aforementioned surfaces along with alternative treatments such as mechanically encapsulated aggregate and turf surfaces should be investigated.

## CHAPTER 4 – ENVIRONMENTAL CONDITIONS

Introduction: Chapter 4 is a preliminary assessment of potential environmental impacts and will require further investigation. Prior to design, a full environmental assessment of the corridor will need to identify potential environmental impacts as well as the permits and approvals that may be required prior to project construction.

Wetlands: A review of the GIS information provided to B&L by the Ulster County Department of the Environment revealed several locations of National and New York State Department of Environmental Conservation (NYSDEC) wetlands and Hydric soils throughout the railroad corridor. A field visit performed in October 2014 confirmed the presence of these delineated wetlands. A review of the National Wetland and NYSDEC GIS files obtained from Ulster County revealed wetlands at various locations within and adjacent to the projects anticipated area of impact. An environmental assessment, to be completed prior to design, will review the project site and proposed project to determine the impacts to the existing wetlands. If impacts are anticipated, a NYSDEC and United States Army Corps of Engineers (USACOE) joint application permit for wetland impacts will be submitted.

Surface Waters: The proposed trail will cross several NYSDEC designated Class A streams with A (T) Standards throughout various locations throughout the corridor. According to 6 NYCRR Part 608 Use and Protection of Waters, Class A waters can be used as a source of drinking water. The (T) Standards indicates that the water quality of this stream is sufficient to support trout populations. Various streams throughout the corridor meet NYSDEC's definition of protected water; therefore, a NYSDEC Article 15 Stream Disturbance Permit will be required for any disturbance to the bed or banks of this water resource. Depending on the final design chosen, no alterations to the stream bed or banks are anticipated to any of the streams located within the corridor. If necessary, the required permits will be acquired prior to construction.

Depending on the final design, the proposed trail project may require temporary or permanent fills in Waters of the U.S. It is anticipated that any such work would be authorized under the USACE's Section 404 Nationwide Permit Program. All applicable environmental permits will be obtained once the location and the extent of potential impacts are determined and the project design is finalized. Work will not commence until all required permits are authorized; project construction will adhere to all applicable permit conditions. In addition to a USACE Section 404 permit, a Section 401 Water Quality Certification (WQC) from NYSDEC may also be needed for this project. Coordination with the USACE will commence once the potential impacts are known.

Floodplains: The Federal Emergency Management Agency (FEMA) Flood Insurance Rate Mapping (FIRM) for the project area shows that a portion of the proposed trail corridor lies within a mapped 100-year flood zone (Zone A). The Zone A floodway is the channel of a stream plus any adjacent floodplain areas that must be kept free of encroachment so that the 1% annual chance flood can be carried without substantial increases in flood heights. This mapped flood zone area is associated with Ashokan Reservoir and Esopus Creek. Existing railroad encroachments into this mapped flood zone are in the areas where the railroad is immediately adjacent to the reservoir and creek. No impacts are anticipated to occur to the mapped flood zones. Any alteration to the existing profile of the railroad bed is expected to result in a decrease in the proposed elevation of the trail. This reduction in height will result in a decrease in the overall floodplain elevation; however, this decrease is expected to be insignificant based on the small footprint of the trail when compared to the overall surface area of the floodplain. The FIRM maps are included in Appendix F.

Reservoirs: The trail corridor is positioned along the north side of the Ashokan Reservoir which is a public water supply for the City of New York. The reservoir was formed by the damming of the Esopus Creek. It is imperative that this water supply is protected from erosion of sediment during construction. Coordination with DEP will be ongoing throughout the duration of the project to ensure water quality is not impacted during or post construction.



Stormwater Management: This project will disturb over one acre of land and will therefore require a State Pollution Discharge Elimination System (SPDES) permit. While this project may not be required to assess the requirements for stormwater management practices, such practices will be considered where reasonable and feasible. All appropriate erosion and sediment control measures will be implemented as part of the project design.

A SPDES General Permit for construction activities (GP-0-15-002) will be required as the project results in more than one acre of soil disturbance. A Stormwater Pollution Prevention Plan (SWPPP) with the appropriate sediment and erosion control measures will be developed. The project corridor is adjacent to but will not discharge any contaminated runoff to the Ashokan Reservoir which is a listed 303(d) water body in Appendix E of the General Permit. All stormwater runoff will be contained within the construction operations and treated prior to leaving the site. Placement of erosion and sediment control practices will be designed during the Final Design phase.

Endangered and Threatened Species: The NYSDEC Natural Heritage Program (NHP) was contacted for information regarding the reported presence of any NYS endangered or threatened species or significant habitats located within or adjacent to the project area. A response from the NHP reported one natural community and historical records for one (1) threatened bird and one (1) endangered mammal near the proposed trail corridor. A Vernal Pool which is a wetland/aquatic community near the project site has a high ecological and conservation value. Bluestone is a moderate size vernal pool complex in good condition within a large natural landscape in very good condition. Breeding populations of the Bald Eagle (*Haliaeetus leucocephalus*) were documented within 0.1 mile of the project site while maternity colonies of the Indiana Bat (*Myotis sodalis*) were also documented within 0.1 miles of the project site. Detailed location information for these records is not available. Potential impact to these resources will be determined during final design. A copy of the coordination with the NHP is provided in Appendix F.

An information search regarding federally endangered and threatened species was also conducted for this project. The Department of the Interior (DOI) U.S. Fish and Wildlife Service (USFWS) NY Field Office's Information, Planning and Consultation (IPAC) system was consulted for a list of federally-protected species reported within or near the project area. This database search resulted in the identification of the following species: the threatened bog turtle (*Clemmys muhlenbergii*), the endangered Indiana bat (*Myotis sodalis*), and the proposed endangered Northern Long-Eared Bat (*Myotis septentrionalis*). There are no critical habitats or wildlife refuges within or in the vicinity of the project area.

A habitat assessment and protected species search will be completed during final design by an ecologist to determine if any of the above listed species do, in fact, occupy the proposed project area or if suitable habitat for these listed species is located within the disturbance limits of the project.

Invasive Species: A review of the existing project area did not indicate any significant presence of known invasive species within the project limits. Precautions will be taken to prevent the introduction and establishment of invasive species during project construction using best management practices (BMPs). Care will be taken to prevent the introduction of additional invasive species during project design and construction by ensuring the construction equipment is clean and that any plantings incorporated into the project design are not recognized as invasive species.

Historic and Cultural Resources: A review of the Cultural Resource Information System (CRIS), a resource located on the New York State Historic Preservation Office (SHPO) website that is used to locate cultural resources, indicated that sections of the corridor are located in archeologically sensitive areas. The CRIS also indicated that a structure, the Reservoir Road overpass, has been reviewed and determined that the structure is not eligible to be listed on the National Register as a historical structure. Coordination with the SHPO will occur during final design, once the Area of Potential Effect (APE) to the corridor has been determined. This will help to determine if the project will have any impacts to the archeologically sensitive areas listed by the CRIS.

Farmlands: A review of GIS data supplied to B&L by the Ulster County Department of the Environment revealed that the railroad corridor passes through areas of land designated as Prime Farmland, Farmland of Statewide Importance, and Prime Farmland if Drained. Currently, no active or inactive farms or pastures exist on or adjacent to the railroad corridor. The corridor consists of mainly forested lands. No undisturbed lands are anticipated to be acquired to construct the proposed rail trail. The trail will be constructed on the existing previously-disturbed railroad footprint.

Asbestos: An asbestos screening of the project area will be completed by a New York State Department of Labor (NYSDOL) certified Asbestos Inspector during the Final Design phase of this project. All testing will be in accordance with the applicable State and Federal regulations and the applicable New York State Department of Transportation (NYSDOT) requirements. Existing railroad infrastructure, such as box culverts and signal foundations from the early 1900's likely contain Asbestos Containing Material (ACM) and will be investigated further in the Environmental Assessment.

Hazardous Waste and Contaminated Materials: A Hazardous Waste/Contaminated Materials Site Screening will be conducted during Final Design in accordance with NYSDOT's TEM, Chapter 5, in order to document the likely presence or absence of hazardous/contaminated environmental conditions. A hazardous or contaminated environmental condition is the presence or likely presence of any hazardous substances or petroleum products (including products currently in compliance with applicable regulations) on a property under conditions that indicate an existing release, a past release, or a material threat of a release of any hazardous substances or petroleum products into structures on the property or into the ground, ground water, or surface water of the property.

A Hazardous Waste/Contaminated Materials Site Screening "Phase 1 Environmental Site Assessment" would include a review of NYSDEC regulatory data files and results from a site walkover. NYSDEC databases containing information on chemical spills, hazardous waste sites, and petroleum bulk storage locations will be examined for possible hazardous or contaminated materials in the project area.

## **Appendix A**

### **Plans and Typical Sections**

cmh  
 L:\MicroStation\workspace\Plot\NYSDOT\NYSDOT\_SIZE\_B - HPM712.tbl  
 L:\MicroStation\workspace\Plot\NYSDOT\NYSDOT.LJ5000.B.04.00.plt

FILE NAME = L:\NSTN\Projects\1600\1653.002.001 - CMRT Phase 2\NSTN\Design Report\1653.002 TS 1.dgn  
 DATE = 2/27/2015  
 TIME = 8:47:11 AM

IN CHARGE OF \_\_\_\_\_ DESIGNED BY \_\_\_\_\_ CHECKED BY \_\_\_\_\_ DRAFTED BY \_\_\_\_\_ CHECKED BY \_\_\_\_\_

PREPARED BY:  
 ON:

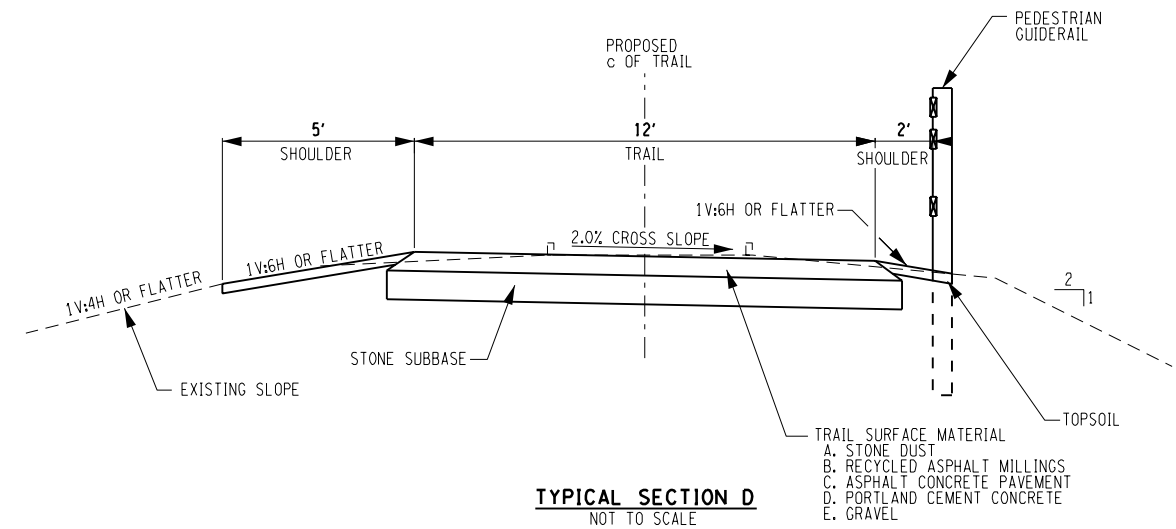
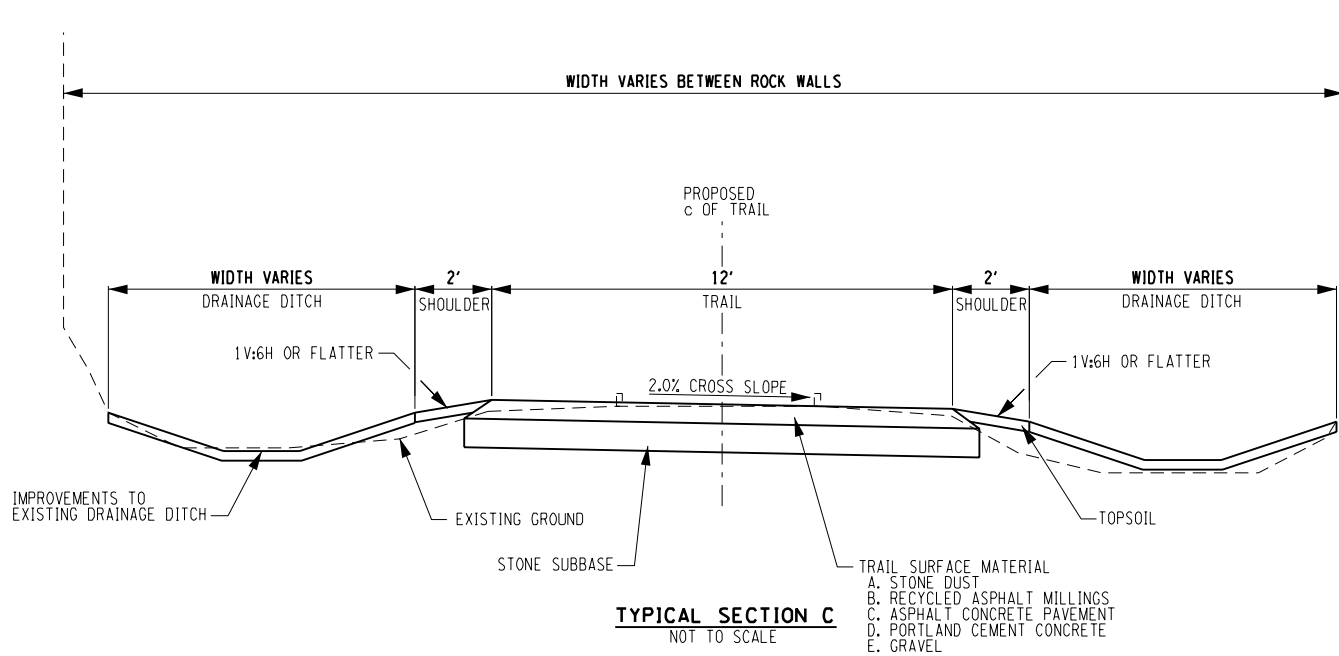
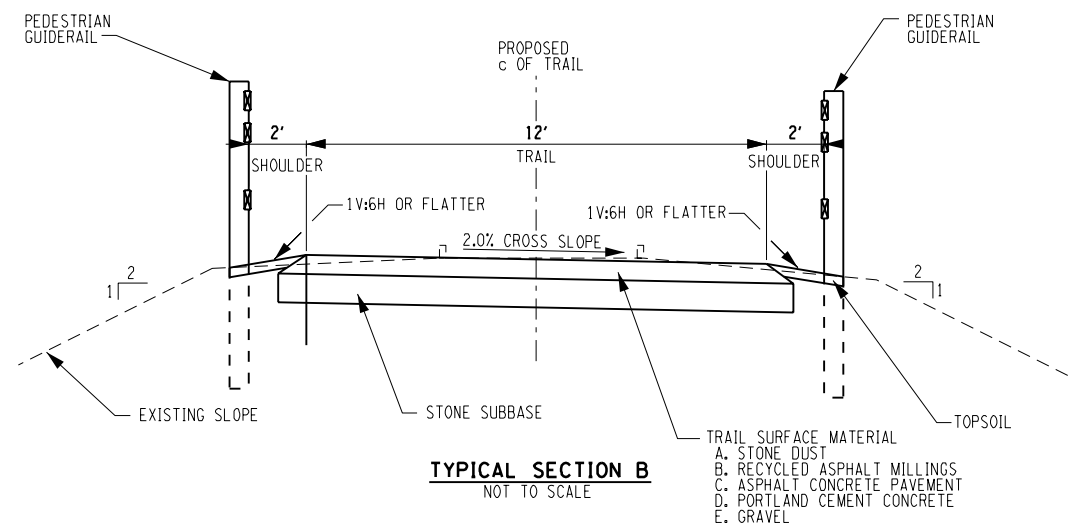
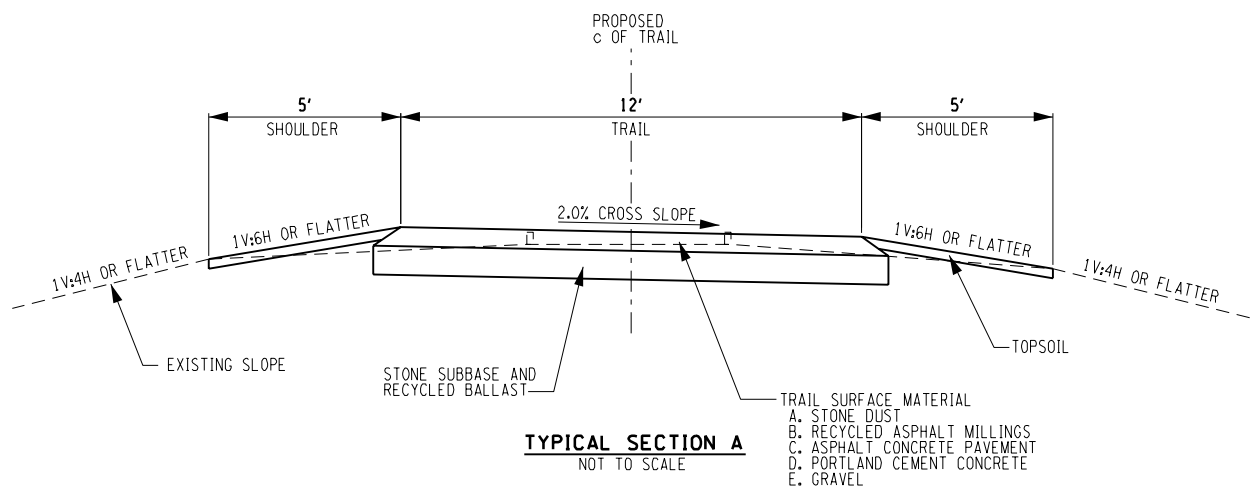

NO.	DATE	BY	REVISION



**Barton B&Loguice, D.P.C.**

UNAUTHORIZED ALTERATION OR ADDITION TO THIS DRAWING IS A VIOLATION OF THE NEW YORK STATE EDUCATION LAW, ARTICLE 145 SECTION 7209

CATSKILL MOUNTAIN RAIL TRAIL ASHOKAN SECTION	OPEN SPACE INSTITUTE	ULSTER COUNTY	ALTERNATIVE 1 A
--	----------------------	---------------	-----------------

TYPICAL SECTION 1
SCALE: NONE
DATE ISSUED: 02/2015
DRAWING TS - 1

XX

L:\MicroStation\Workspace\Pilot\NYSDOT\NYS DOT SITE B.tbl  
 L:\MicroStation\Workspace\Pilot\NYSDOT\NYS DOT.LJ5000.B.04.009.plt

FILE NAME = I:\mstr\_projects\1600\1653\002\001 - cmt phase 2\mstr\design report\1653\002 PL 01.dgn  
 DATE = 2/25/2015  
 TIME = 3:51:14 PM

IN CHARGE OF \_\_\_\_\_ DESIGNED BY \_\_\_\_\_ CHECKED BY \_\_\_\_\_ DRAFTED BY \_\_\_\_\_ CHECKED BY \_\_\_\_\_

PREPARED BY:  
 ON:

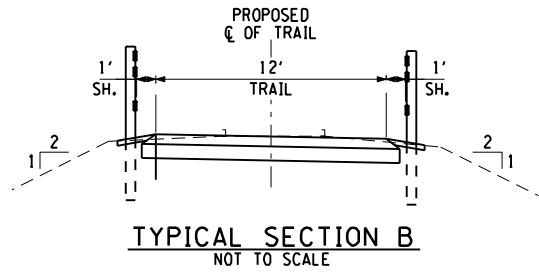
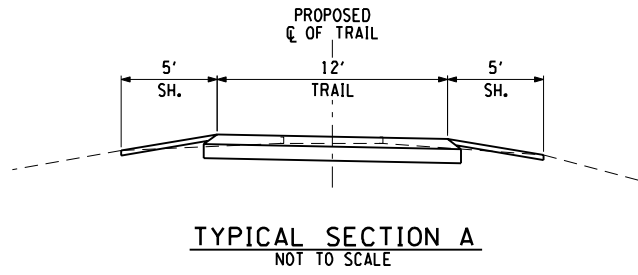
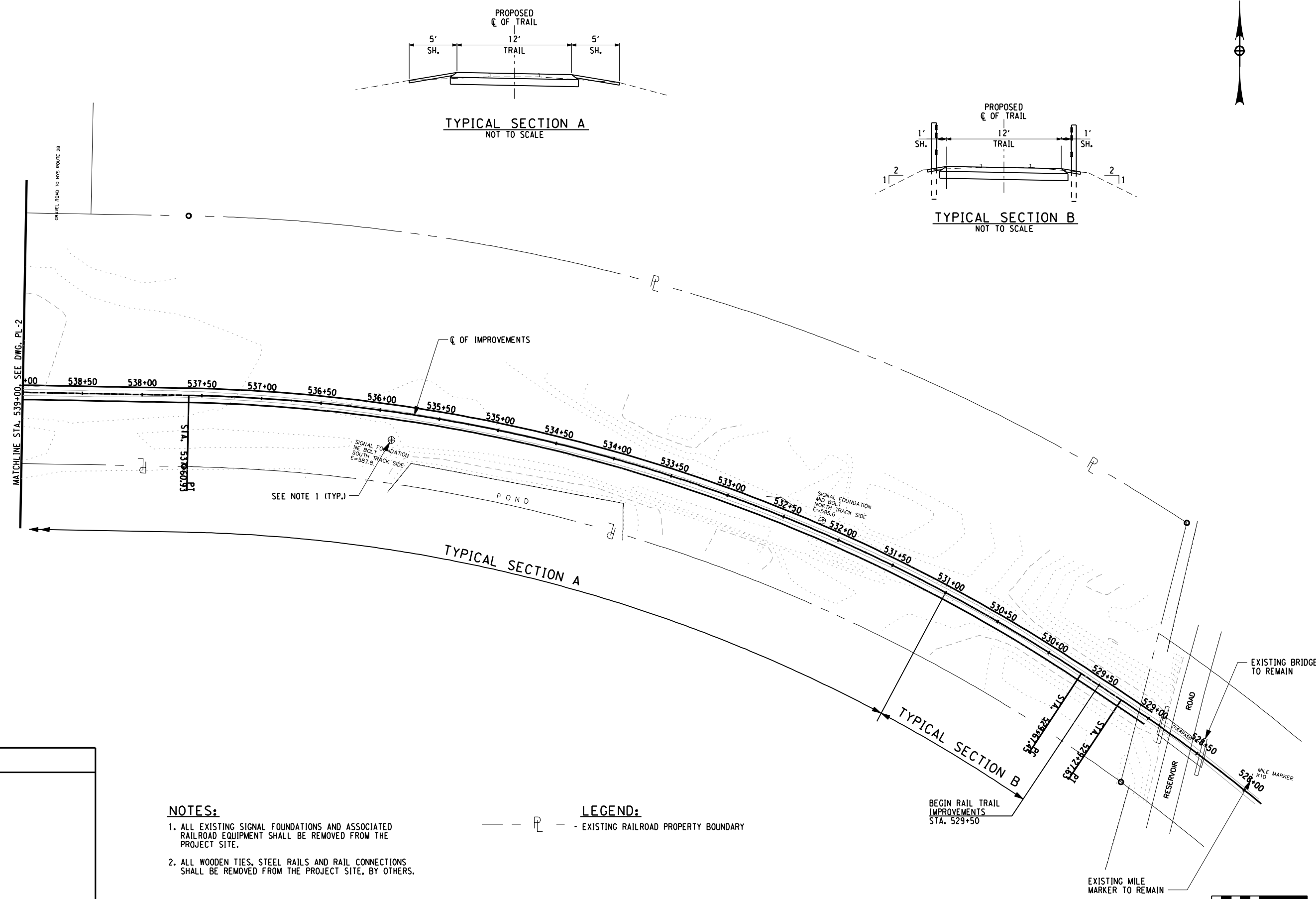

- NOTES:**
1. ALL EXISTING SIGNAL FOUNDATIONS AND ASSOCIATED RAILROAD EQUIPMENT SHALL BE REMOVED FROM THE PROJECT SITE.
  2. ALL WOODEN TIES, STEEL RAILS AND RAIL CONNECTIONS SHALL BE REMOVED FROM THE PROJECT SITE, BY OTHERS.

**LEGEND:**  
 --- P --- EXISTING RAILROAD PROPERTY BOUNDARY

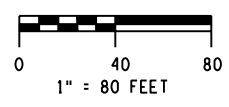

NO.	DATE	BY	REVISION

**OPEN SPACE INSTITUTE**

**Barton & Loguidice, D.P.C.**

UNAUTHORIZED ALTERATION OR ADDITION TO THIS DRAWING IS A VIOLATION OF THE NEW YORK STATE EDUCATION LAW ARTICLE 148 SECTION 7208

CATSKILL MOUNTAIN RAIL TRAIL ASHOKAN SECTION
OPEN SPACE INSTITUTE
ULSTER COUNTY
ALTERNATIVE 1A

<b>GENERAL PLAN 1</b>
SCALE: 1" = 80'
DATE ISSUED: 02/2015
DRAWING PL - 1

XX

cmh  
 L:\MicroStation\Workspace\Plot\NYSDOT\NYS DOT SITE B.tbl  
 L:\MicroStation\Workspace\Plot\NYS DOT\NYS DOT.LJ5000.B.04.009.plt

FILE NAME = I:\mstr\_projects\1600\1653.002.001 - cmrt phase 2\mstr\design report\1653.002 PL 02.dgn  
 DATE = 2/25/2015  
 TIME = 3:51:16 PM

IN CHARGE OF \_\_\_\_\_ DESIGNED BY \_\_\_\_\_ CHECKED BY \_\_\_\_\_ DRAFTED BY \_\_\_\_\_ CHECKED BY \_\_\_\_\_

PREPARED BY:  
 ON:

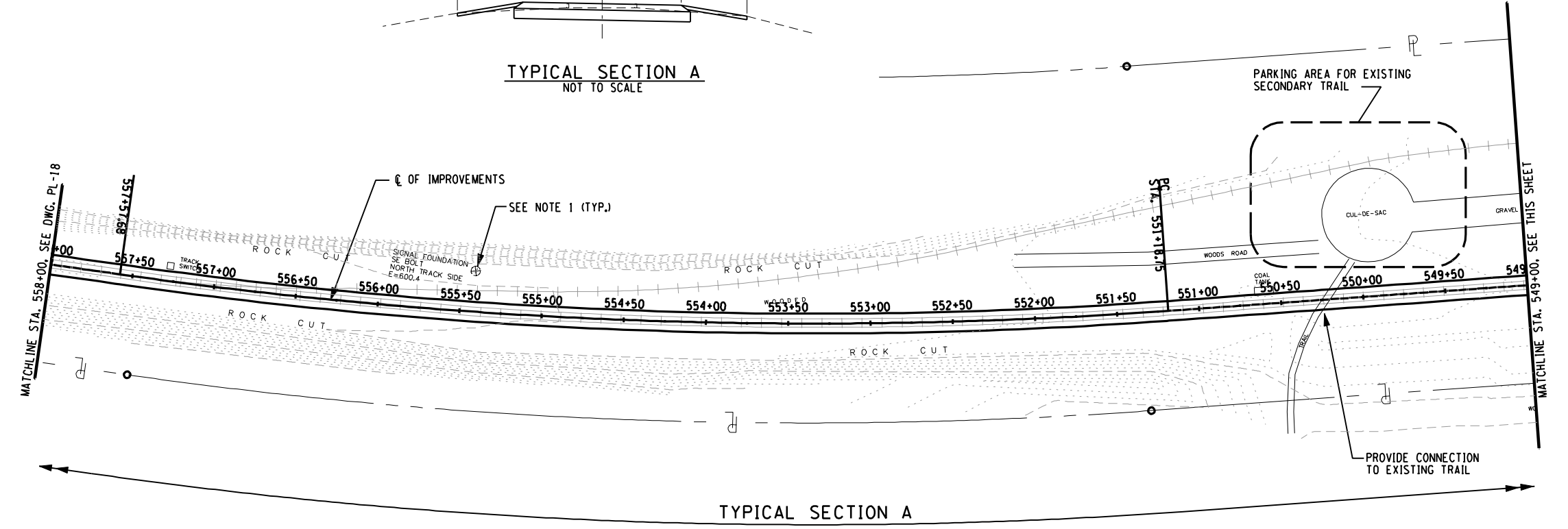
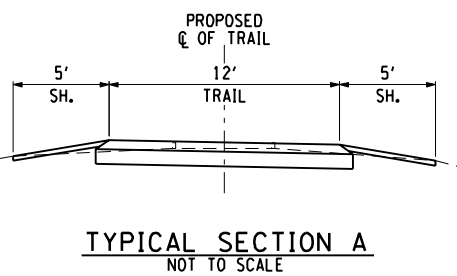
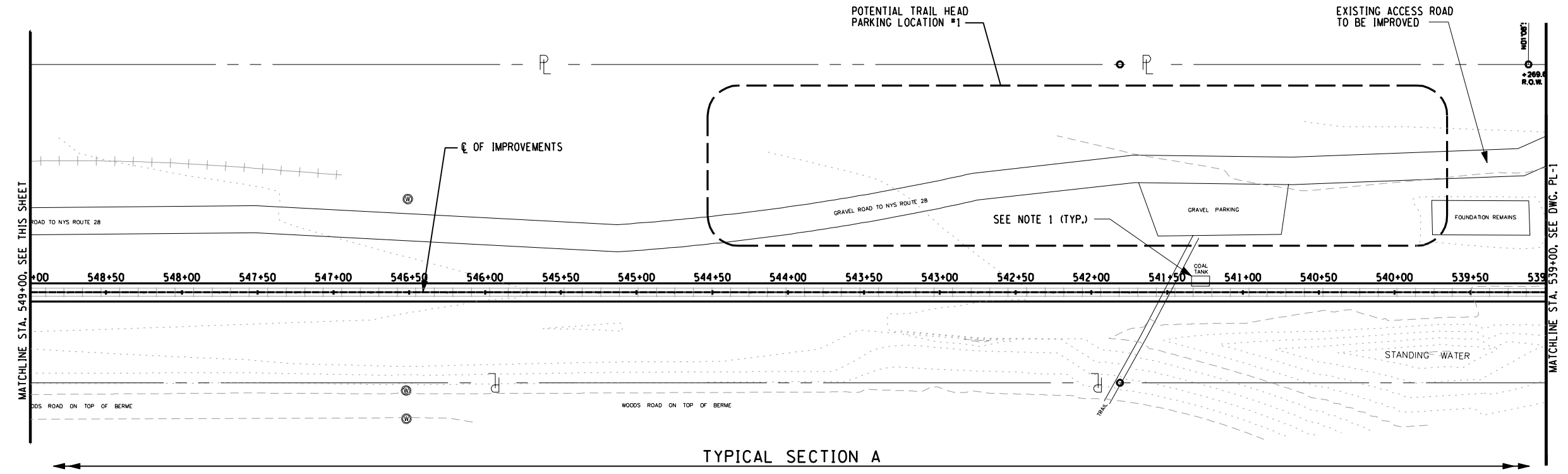

**NOTES:**  
 1. FOR NOTES AND LEGEND, SEE DWG. PL-1

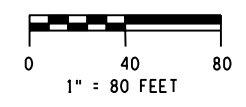

NO.	DATE	BY	REVISION



**Barton**  
**B&E** oguidice, D.P.C.  
 UNAUTHORIZED ALTERATION OR ADDITION TO THIS DRAWING IS A VIOLATION OF THE NEW YORK STATE EDUCATION LAW ARTICLE 145 SECTION 7209

CATSKILL MOUNTAIN RAIL TRAIL  
 ASHOKAN SECTION  
 OPEN SPACE INSTITUTE  
 ULSTER COUNTY  
 ALTERNATIVE 1A

GENERAL PLAN 2  
 SCALE: 1" = 80'  
 DATE ISSUED: 02/2015  
 DRAWING PL - 2

XX

L:\MicroStation\Workspace\Plot\NYSDOT\NYSDOT\_SITE\_B.tbl  
 L:\MicroStation\Workspace\Plot\NYSDOT\NYSDOT.LJ5000.B.04.009.plt

FILE NAME = I:\mstr\_projects\1600\1653\002\001 - cmt phase 2\mstr\design report\1653\002 PL 03.dgn  
 DATE = 2/25/2015  
 TIME = 3:51:18 PM

IN CHARGE OF \_\_\_\_\_  
 DESIGNED BY \_\_\_\_\_  
 CHECKED BY \_\_\_\_\_  
 DRAFTED BY \_\_\_\_\_  
 CHECKED BY \_\_\_\_\_

PREPARED BY:  
 ON:

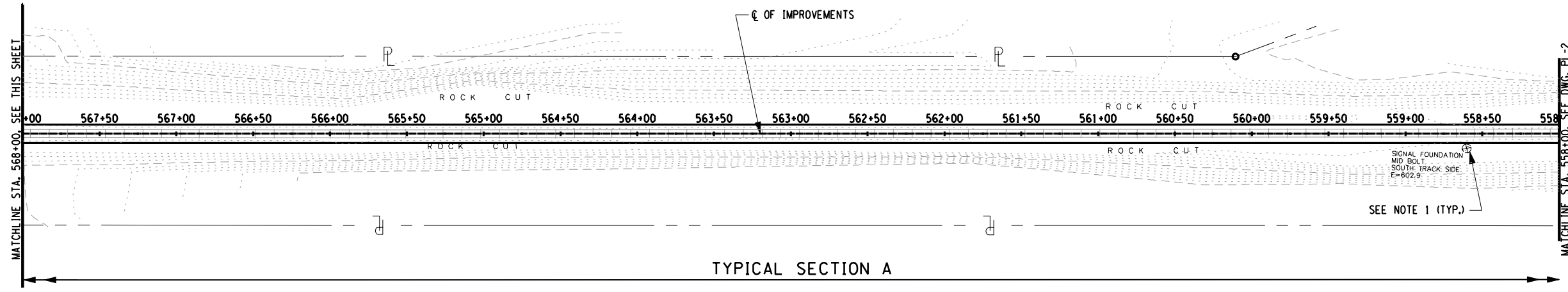
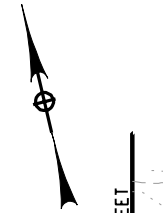

TYPICAL SECTION A

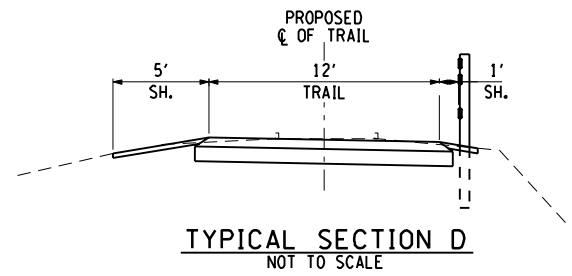

TYPICAL SECTION D  
 NOT TO SCALE

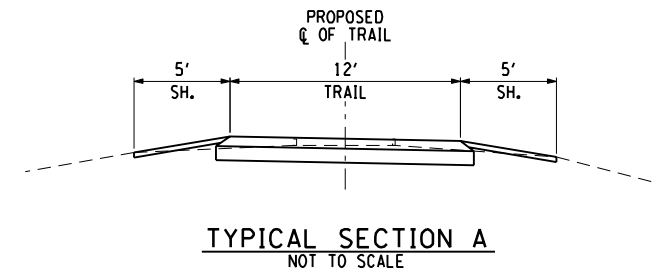

TYPICAL SECTION A  
 NOT TO SCALE

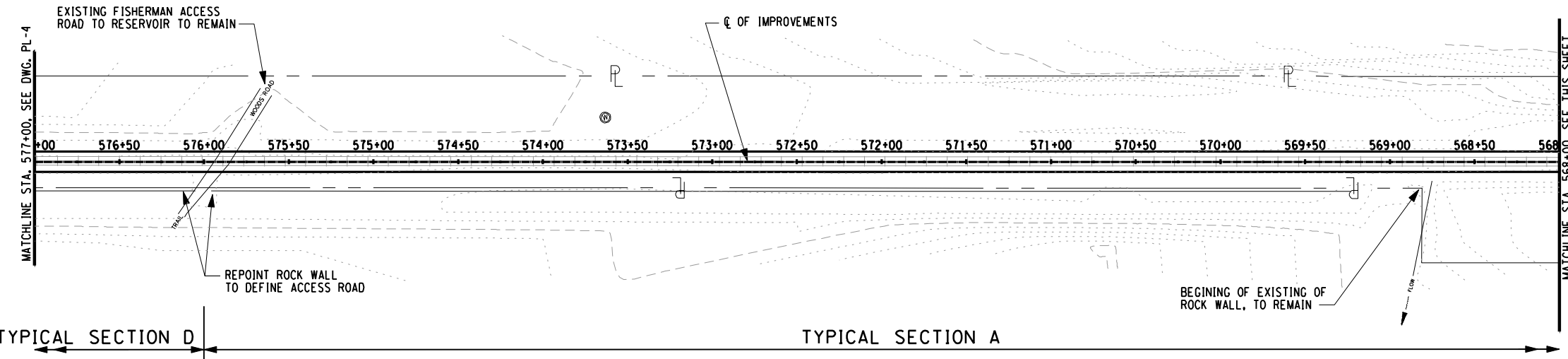

TYPICAL SECTION D

TYPICAL SECTION A

NOTES:  
 1. FOR NOTES AND LEGEND, SEE DWG. PL-1

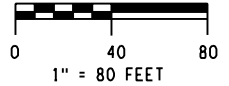

NO.	DATE	BY	REVISION



**Barton**  
**B&E** **Loguidice, D.P.C.**  
 UNAUTHORIZED ALTERATION OR ADDITION TO THIS  
 DRAWING IS A VIOLATION OF THE NEW YORK STATE  
 EDUCATION LAW ARTICLE 145 SECTION 7209

CATSKILL MOUNTAIN RAIL TRAIL  
 ASHOKAN SECTION  
 OPEN SPACE INSTITUTE  
 ULSTER COUNTY  
 ALTERNATIVE 1A

GENERAL  
 PLAN 3  
 SCALE: 1" = 80'  
 DATE ISSUED: 02/2015  
 DRAWING  
 PL - 3

XX

cmh  
 L:\MicroStation\Workspace\Plot\NYSOOT\SITE\NYSOOT\_SIZE\_B.tbl  
 L:\MicroStation\Workspace\Plot\NYSOOT\NYSOOT.LJ5000.B.04.00b.plt

FILE NAME = I:\mstr\_projects\1600\1653\002\001 - cmrt phase 2\mstr\design report\1653\002 PL 04.dgn  
 DATE = 2/25/2015  
 TIME = 3:51:20 PM

IN CHARGE OF \_\_\_\_\_ DESIGNED BY \_\_\_\_\_ CHECKED BY \_\_\_\_\_ DRAFTED BY \_\_\_\_\_ CHECKED BY \_\_\_\_\_

PREPARED BY:  
 ON:

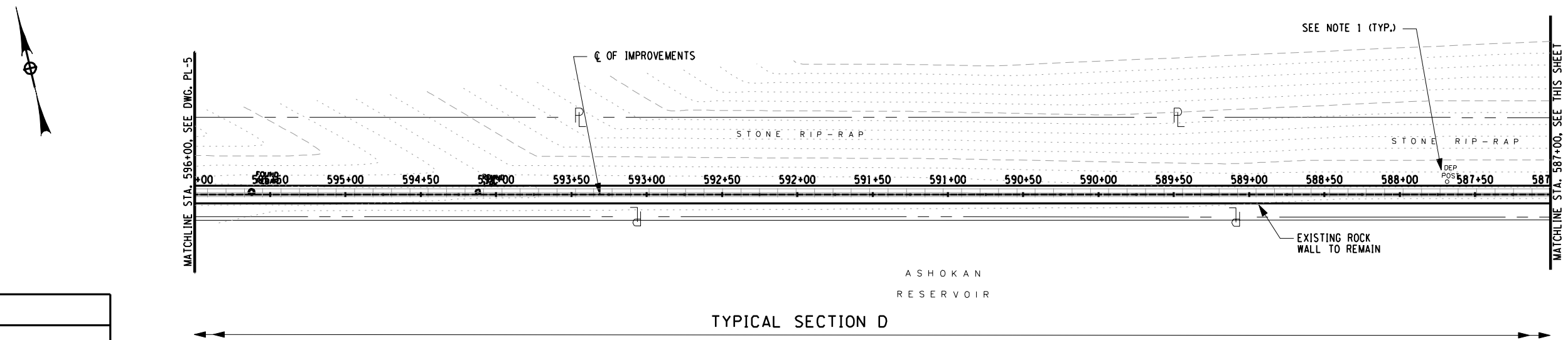
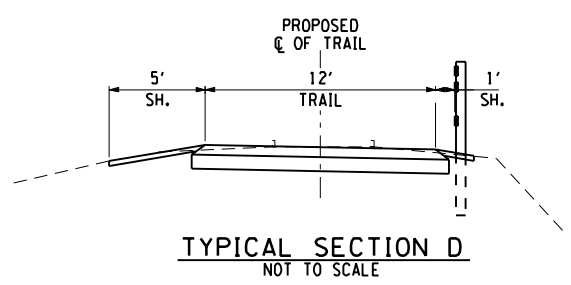
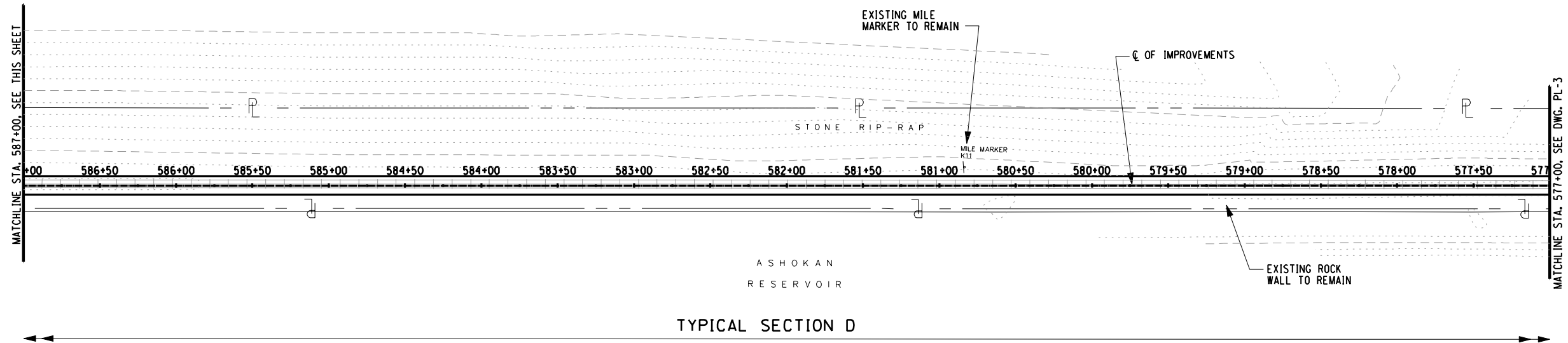

NOTES:  
 1. FOR NOTES AND LEGEND, SEE DWG. PL-1

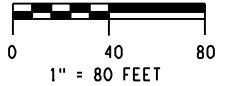

NO.	DATE	BY	REVISION



**Barton & Loguidice, D.P.C.**  
 UNAUTHORIZED ALTERATION OR ADDITION TO THIS DRAWING IS A VIOLATION OF THE NEW YORK STATE EDUCATION LAW ARTICLE 145 SECTION 7209

CATSKILL MOUNTAIN RAIL TRAIL  
 ASHOKAN SECTION  
 OPEN SPACE INSTITUTE  
 ULSTER COUNTY  
 ALTERNATIVE 1A

GENERAL PLAN 4  
 SCALE: 1" = 80'  
 DATE ISSUED: 02/2015  
 DRAWING PL - 4

XX



L:\MicroStation\Workspace\Plot\NYSDOT\NYS00T\SITE\B.tbl  
 L:\MicroStation\Workspace\Plot\NYSDOT\NYS00T.LJ5000.B.04.00.pit

FILE NAME = I:\mstr\_projects\1600\1653\002\001 - cmrt phase 2\mstr\design report\1653\002 PL 05.dgn  
 DATE = 2/25/2015  
 TIME = 3:51:22 PM

IN CHARGE OF \_\_\_\_\_ DESIGNED BY \_\_\_\_\_ CHECKED BY \_\_\_\_\_ DRAFTED BY \_\_\_\_\_ CHECKED BY \_\_\_\_\_

PREPARED BY:  
 ON:

**NOTES:**  
 1. FOR NOTES AND LEGEND, SEE DWG. PL-1

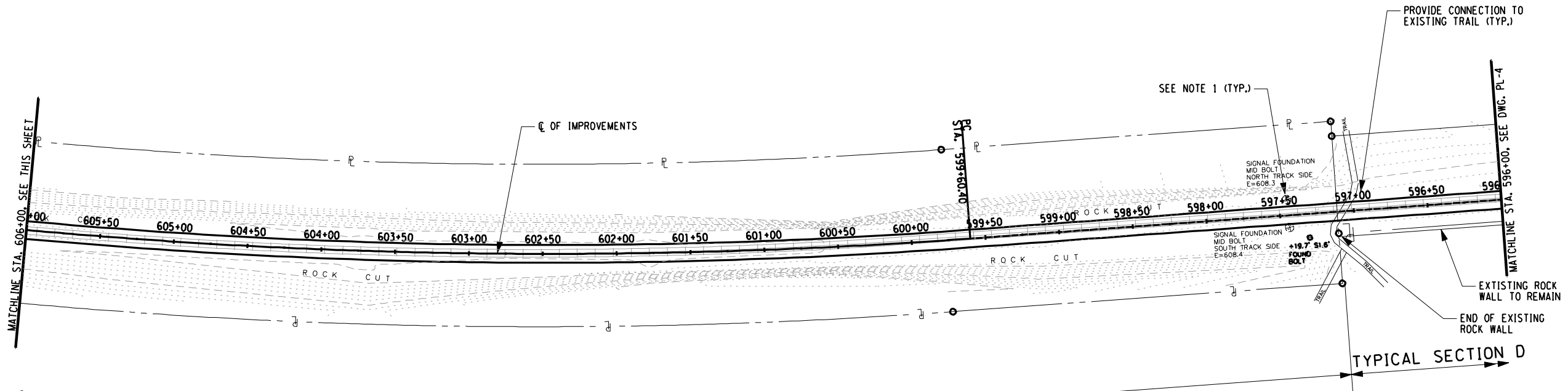

TYPICAL SECTION A

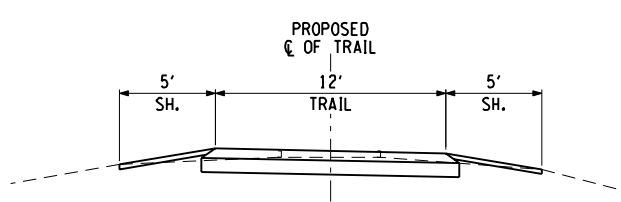

TYPICAL SECTION A  
 NOT TO SCALE

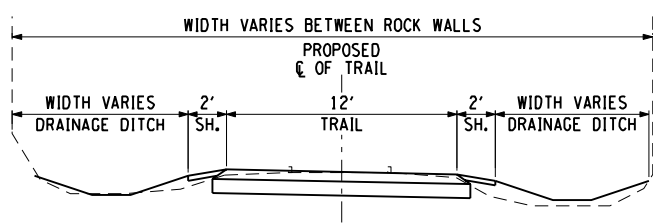

TYPICAL SECTION C  
 NOT TO SCALE

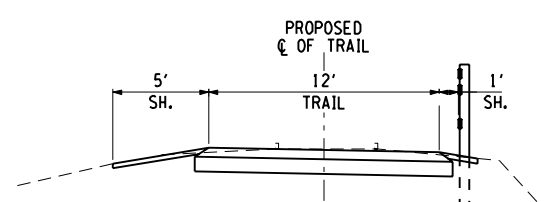

TYPICAL SECTION D  
 NOT TO SCALE

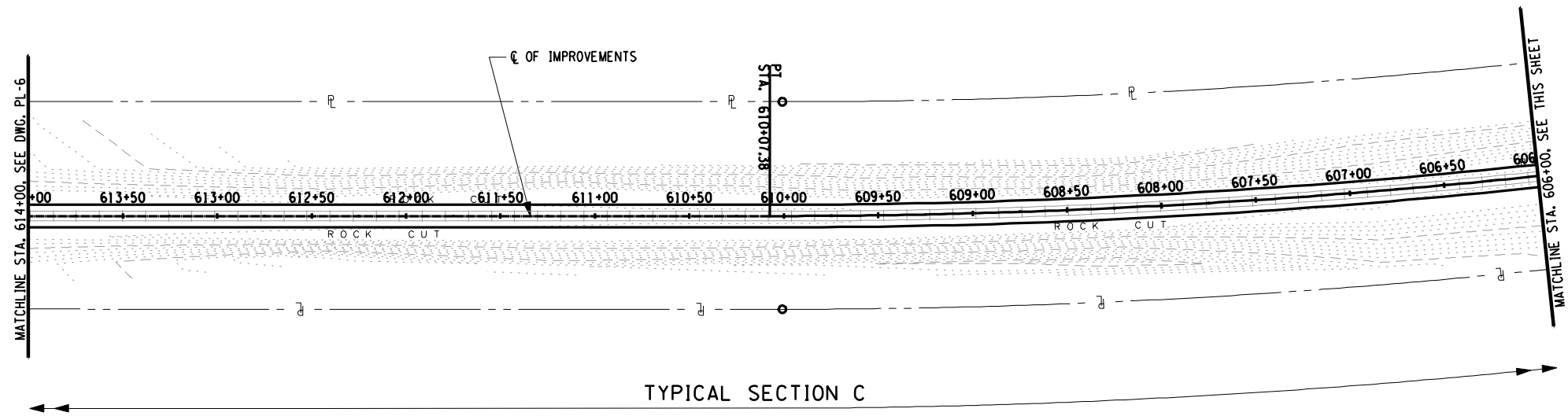
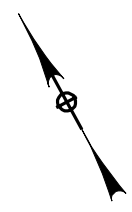

TYPICAL SECTION C

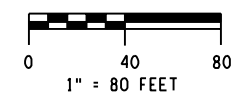

NO. DATE BY REVISION	
<b>Barton</b> <b>B&amp;E</b> <i>Engineering, D.P.C.</i>	
<small>UNAUTHORIZED ALTERATION OR ADDITION TO THIS DRAWING IS A VIOLATION OF THE NEW YORK STATE EDUCATION LAW ARTICLE 145 SECTION 7209</small>	
CATSKILL MOUNTAIN RAIL TRAIL ASHOKAN SECTION	OPEN SPACE INSTITUTE
ULSTER COUNTY	ALTERNATIVE 1A
<b>GENERAL PLAN 5</b>	
SCALE: 1" = 80'	
DATE ISSUED: 02/2015	
DRAWING PL - 5	

XX

L:\MicroStation\Workspace\Plot\NYSDOT\NYSDOT\_SITE\_B.tbl  
 L:\MicroStation\Workspace\Plot\NYSDOT\NYSDOT.LJ5000.B.04.009.plt

FILE NAME = I:\mstr\_projects\1600\1653.002.001 - cmt phase 2\mstr\design report\1653.002 PL 06.dgn  
 DATE = 2/25/2015  
 TIME = 3:51:24 PM

DESIGNED BY \_\_\_\_\_ CHECKED BY \_\_\_\_\_ DRAFTED BY \_\_\_\_\_ CHECKED BY \_\_\_\_\_

PREPARED BY:  
 ON:

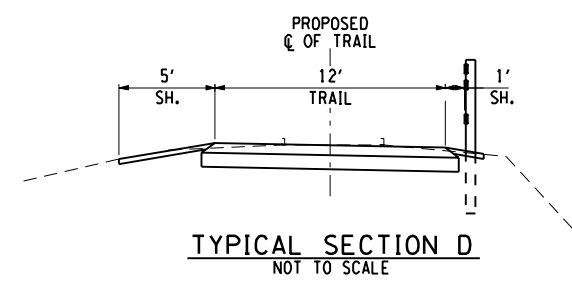
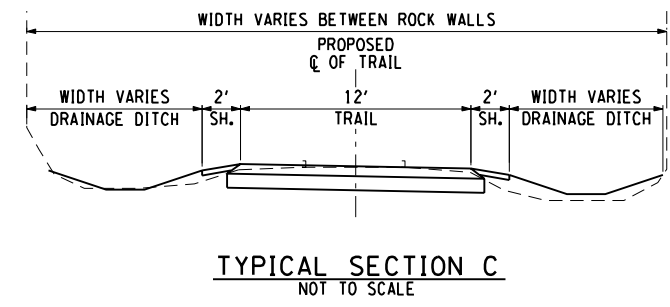
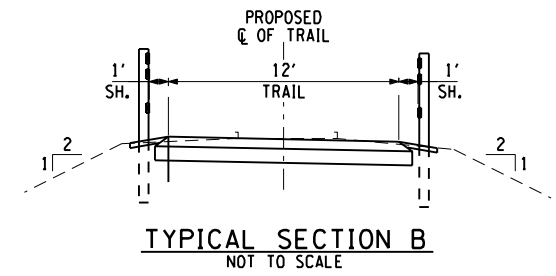
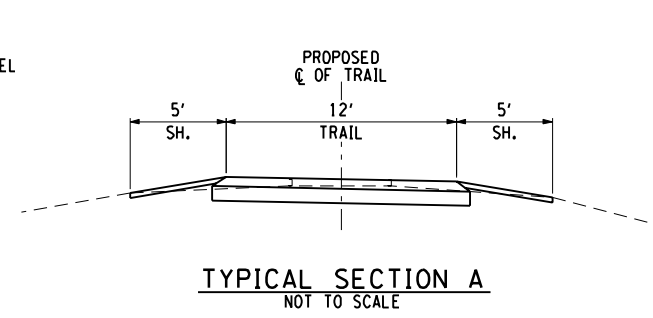
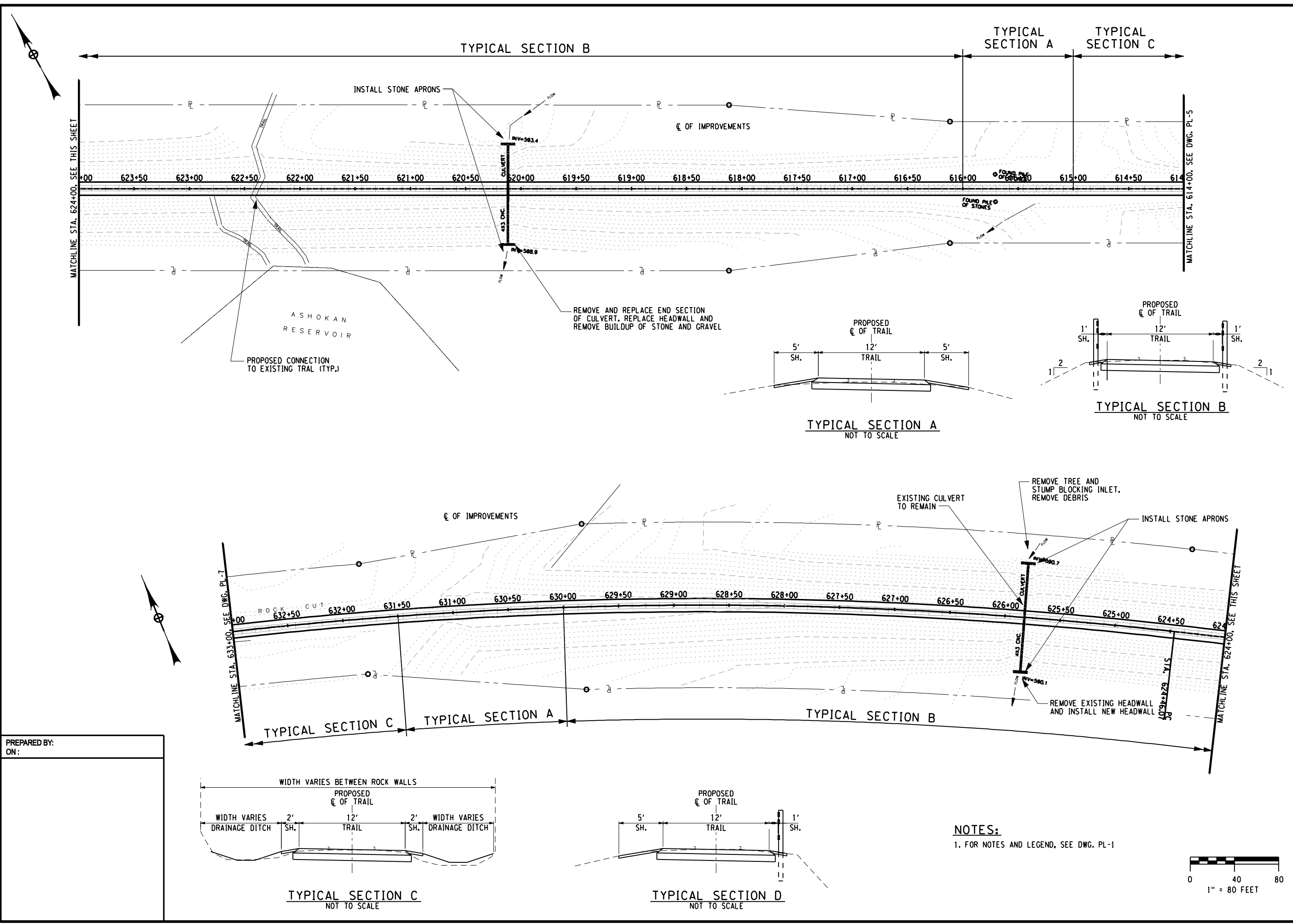

**NOTES:**  
 1. FOR NOTES AND LEGEND, SEE DWG. PL-1

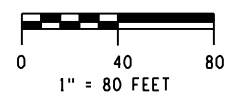

NO. DATE BY REVISION	
 <b>OPEN SPACE INSTITUTE</b>	
 <b>Barton &amp; Loguidice, D.P.C.</b>	
UNAUTHORIZED ALTERATION OR ADDITION TO THIS DRAWING IS A VIOLATION OF THE NEW YORK STATE EDUCATION LAW ARTICLE 148 SECTION 7209	
CATSKILL MOUNTAIN RAIL TRAIL ASHOKAN SECTION	OPEN SPACE INSTITUTE
ULSTER COUNTY	ALTERNATIVE 1A
<b>GENERAL PLAN 6</b>	
SCALE: 1" = 80'	
DATE ISSUED: 02/2015	
DRAWING PL - 6	

XX

cmh  
 L:\MicroStation\Workspace\Plot\NYSDOT\SITE\_NYSDOT\_SIZE\_B.tbl  
 L:\MicroStation\Workspace\Plot\NYSDOT\NYSDOT.LJ5000.B.04.00b.plt

FILE NAME = I:\mstr\_projects\1600\1653\002\001 - cmt phase 2\mstr\design report\1653\002 PL 07.dgn  
 DATE = 2/25/2015  
 TIME = 3:51:26 PM

IN CHARGE OF \_\_\_\_\_  
 DESIGNED BY \_\_\_\_\_  
 CHECKED BY \_\_\_\_\_  
 DRAFTED BY \_\_\_\_\_  
 CHECKED BY \_\_\_\_\_

PREPARED BY:  
 ON:

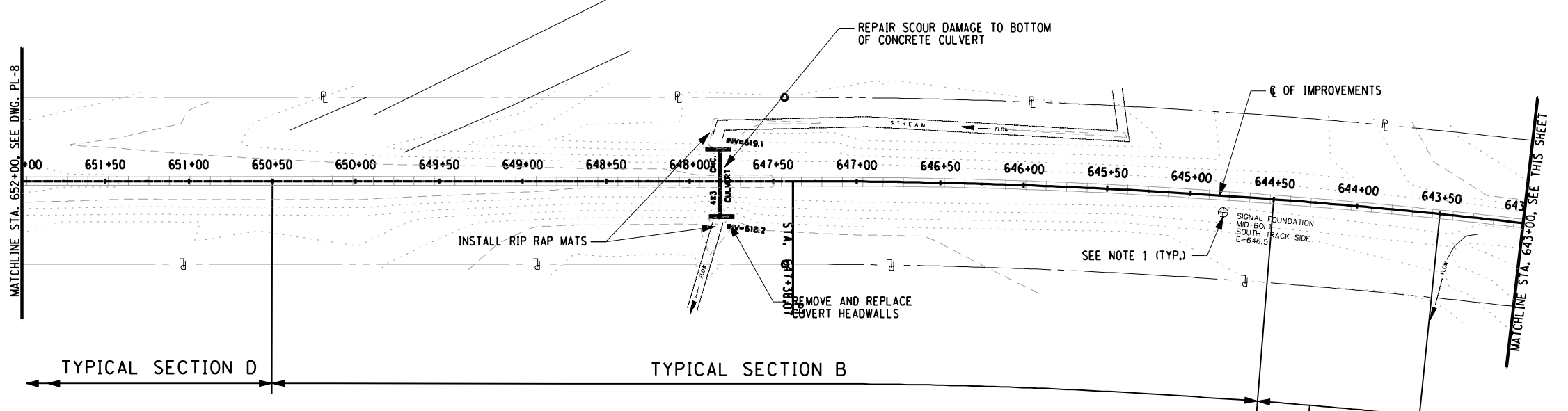
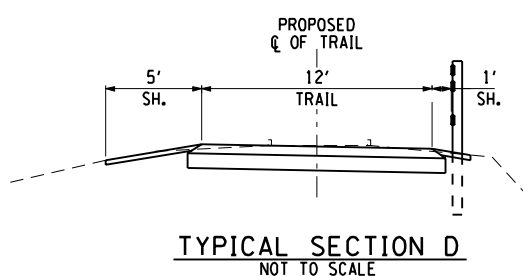
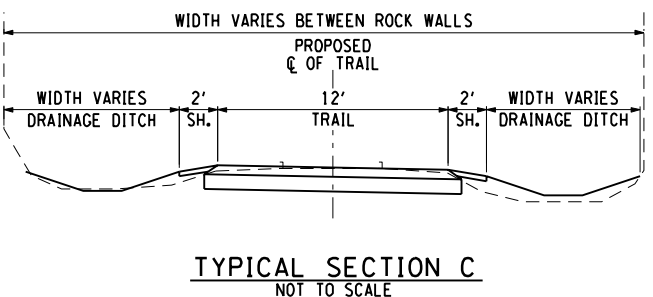
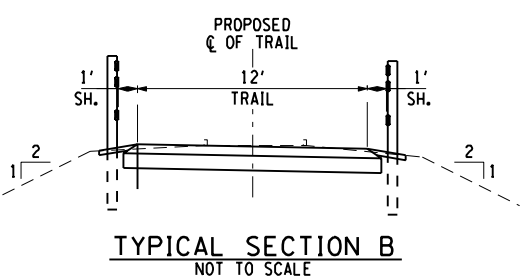
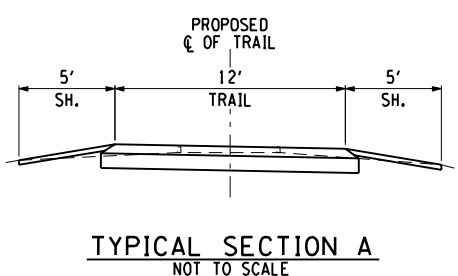
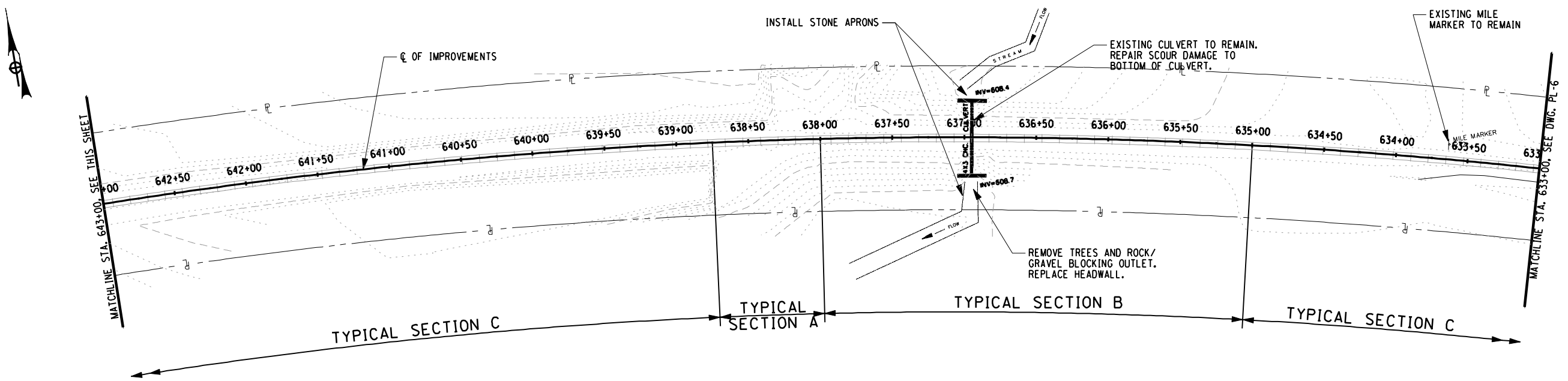

NOTES:  
 1. FOR NOTES AND LEGEND, SEE DWG. PL-1

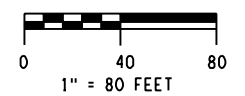

NO.	DATE	BY	REVISION



**Barton**  
**B&E** **Loguidice, D.P.C.**  
 UNAUTHORIZED ALTERATION OR ADDITION TO THIS DRAWING IS A VIOLATION OF THE NEW YORK STATE EDUCATION LAW ARTICLE 145 SECTION 7209

CATSKILL MOUNTAIN RAIL TRAIL  
 ASHOKAN SECTION  
 OPEN SPACE INSTITUTE  
 ULSTER COUNTY  
 ALTERNATIVE 1A

GENERAL PLAN 7  
 SCALE: 1:80  
 DATE ISSUED: 02/2015  
 DRAWING PL - 7

XX

cmh  
 L:\MicroStation\Workspace\Plot\NYS\DOT\SITE\NYS\DOT\_SIZE\_B.tbl  
 L:\MicroStation\Workspace\Plot\NYS\DOT\NYS\DOT.LJ5000.B.04.000.plt

FILE NAME = I:\mstrn\_projects\1600\1653.002.001 - cmt phase 2\mstrn\design report\1653.002 PL 08.dgn  
 DATE = 2/25/2015  
 TIME = 3:51:28 PM

DESIGNED BY \_\_\_\_\_ CHECKED BY \_\_\_\_\_  
 DRAFTED BY \_\_\_\_\_ CHECKED BY \_\_\_\_\_  
 IN CHARGE OF \_\_\_\_\_

PREPARED BY:  
 ON:

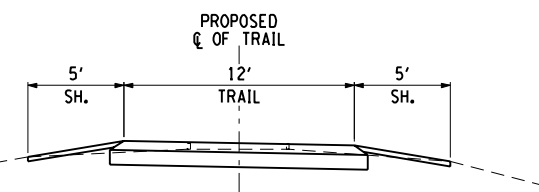
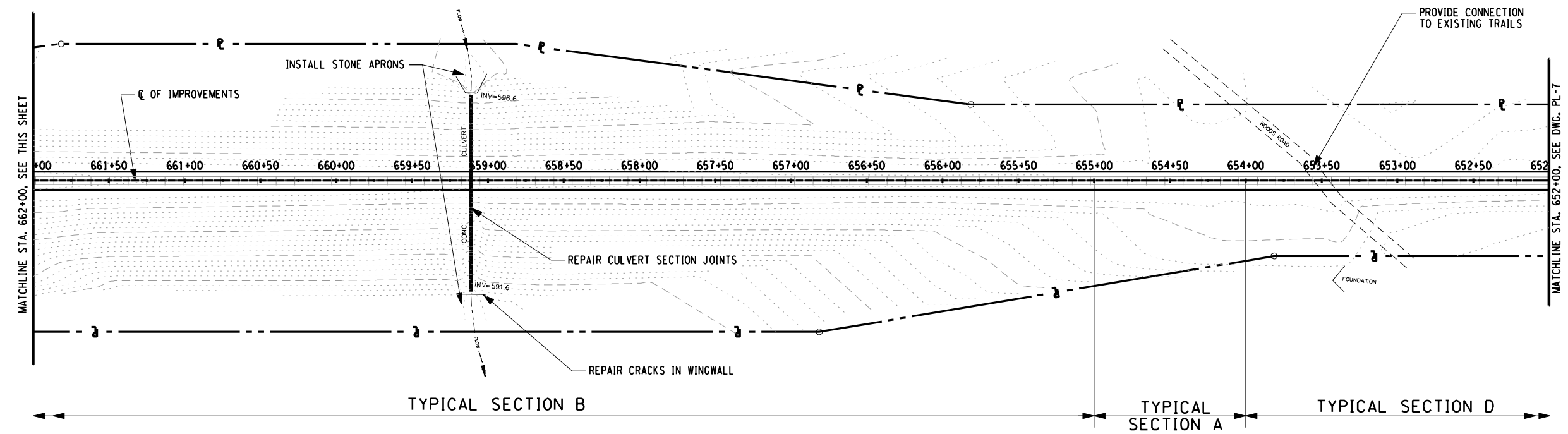

TYPICAL SECTION A  
 NOT TO SCALE

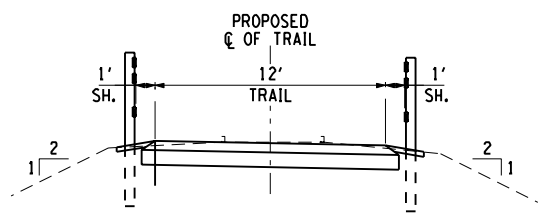

TYPICAL SECTION B  
 NOT TO SCALE

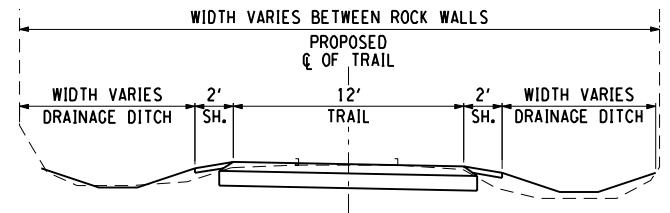

TYPICAL SECTION C  
 NOT TO SCALE

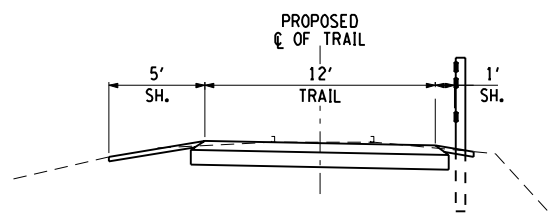

TYPICAL SECTION D  
 NOT TO SCALE

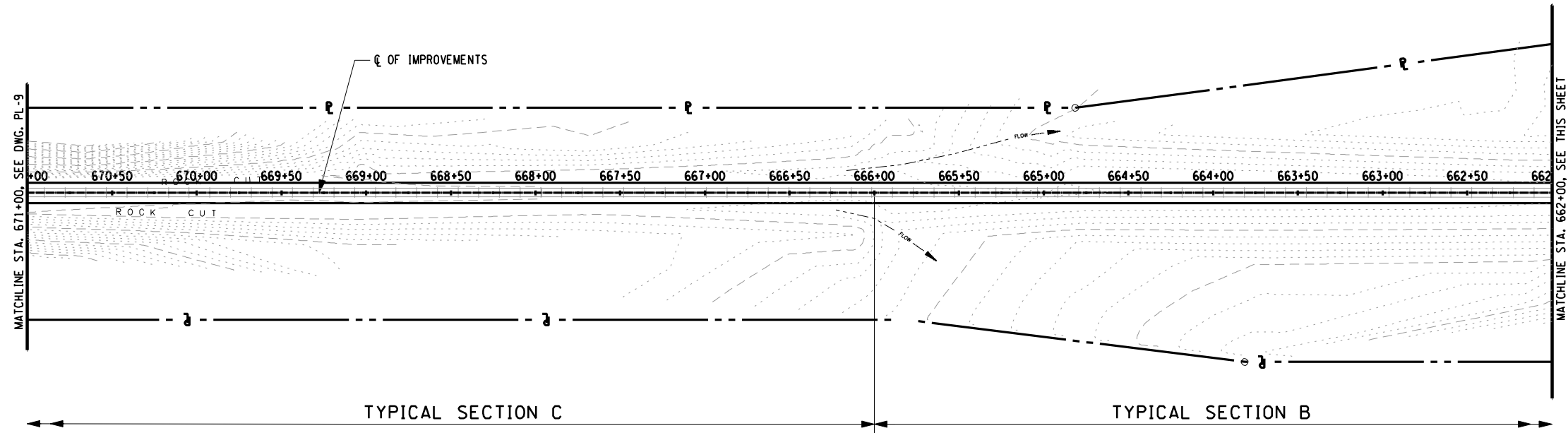

TYPICAL SECTION C

TYPICAL SECTION B

NOTES:  
 1. FOR NOTES AND LEGEND, SEE DWG. PL-1

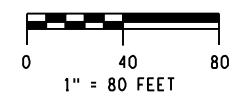

NO. DATE BY REVISION	
 <b>OPEN SPACE INSTITUTE</b>	
 <b>Barton &amp; Loguidice, D.P.C.</b>	
UNAUTHORIZED ALTERATION OR ADDITION TO THIS DRAWING IS A VIOLATION OF THE NEW YORK STATE EDUCATION LAW ARTICLE 145 SECTION 7209	
CATSKILL MOUNTAIN RAIL TRAIL ASHOKAN SECTION	OPEN SPACE INSTITUTE
ULSTER COUNTY	ALTERNATIVE 1A
<b>GENERAL PLAN 8</b>	
SCALE: 1" = 80'	
DATE ISSUED: 02/2015	
DRAWING PL - 8	

XX

L:\MicroStation\Workspace\1653\002\15\1653002\15\1653002.L15000.B.04.009.plt

FILE NAME = I:\mstr\_projects\1600\1653\002\001 - cmt phase 2\mstr\design report\1653\002 PL 09.dgn  
 DATE = 2/25/2015  
 TIME = 3:51:31 PM

IN CHARGE OF \_\_\_\_\_ DESIGNED BY \_\_\_\_\_ CHECKED BY \_\_\_\_\_ DRAFTED BY \_\_\_\_\_ CHECKED BY \_\_\_\_\_

PREPARED BY:  
 ON:

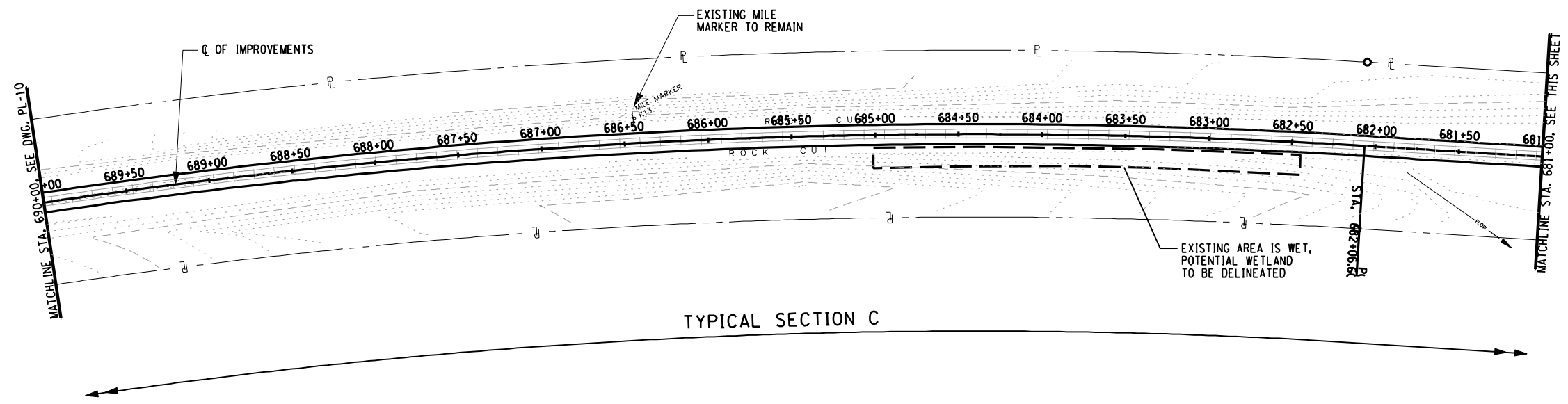
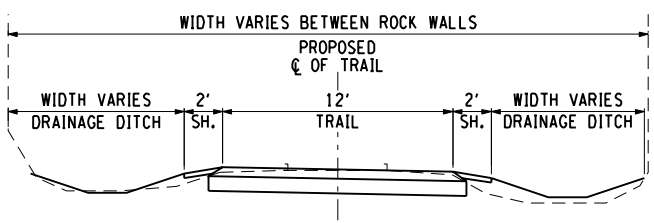
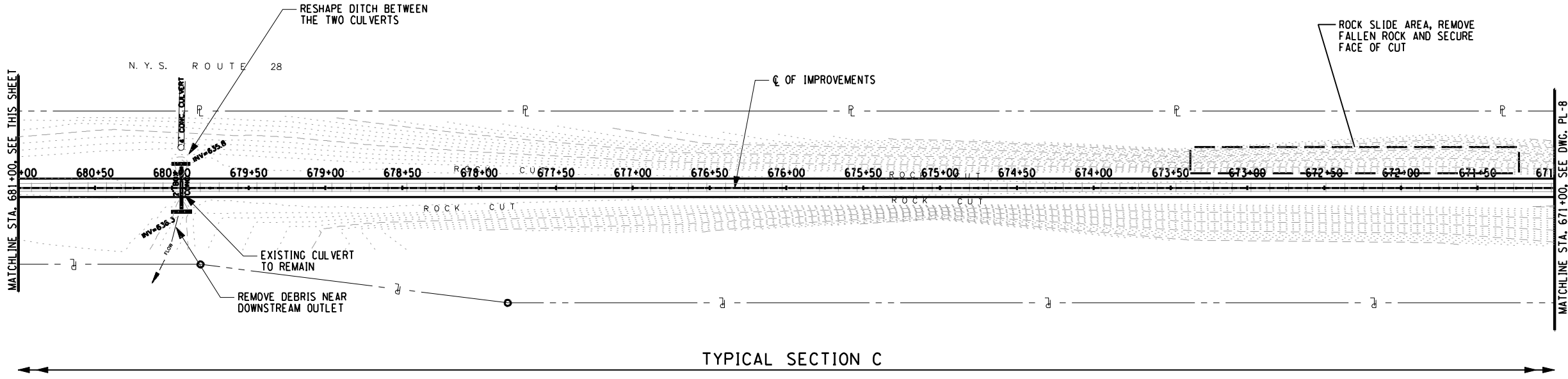

**NOTES:**  
 1. FOR NOTES AND LEGEND, SEE DWG. PL-1

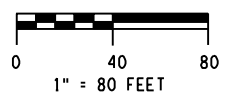

NO.	DATE	BY	REVISION



**Barton & Loguidice, D.P.C.**  
 UNAUTHORIZED ALTERATION OR ADDITION TO THIS DRAWING IS A VIOLATION OF THE NEW YORK STATE EDUCATION LAW ARTICLE 145 SECTION 7209

CATSKILL MOUNTAIN RAIL TRAIL  
 ASHOKAN SECTION  
 OPEN SPACE INSTITUTE  
 ULSTER COUNTY  
 ALTERNATIVE 1A

GENERAL PLAN 9  
 SCALE: 1" = 80'  
 DATE ISSUED: 02/2015  
 DRAWING PL - 9

XX

cmh  
 L:\MicroStation\Workspace\Plot\NYSDOT\SITE\_NYS00T\_SIZE\_B.tbl  
 L:\MicroStation\Workspace\Plot\NYSDOT\NYSDOT.LJ5000.B.04.009.plt

FILE NAME = I:\mstr\_projects\1600\1653.002.001 - cmt phase 2\mstr\design report\1653.002 PL 10.dgn  
 DATE = 2/25/2015  
 TIME = 3:51:33 PM

DESIGNED BY \_\_\_\_\_ CHECKED BY \_\_\_\_\_ DRAFTED BY \_\_\_\_\_ CHECKED BY \_\_\_\_\_

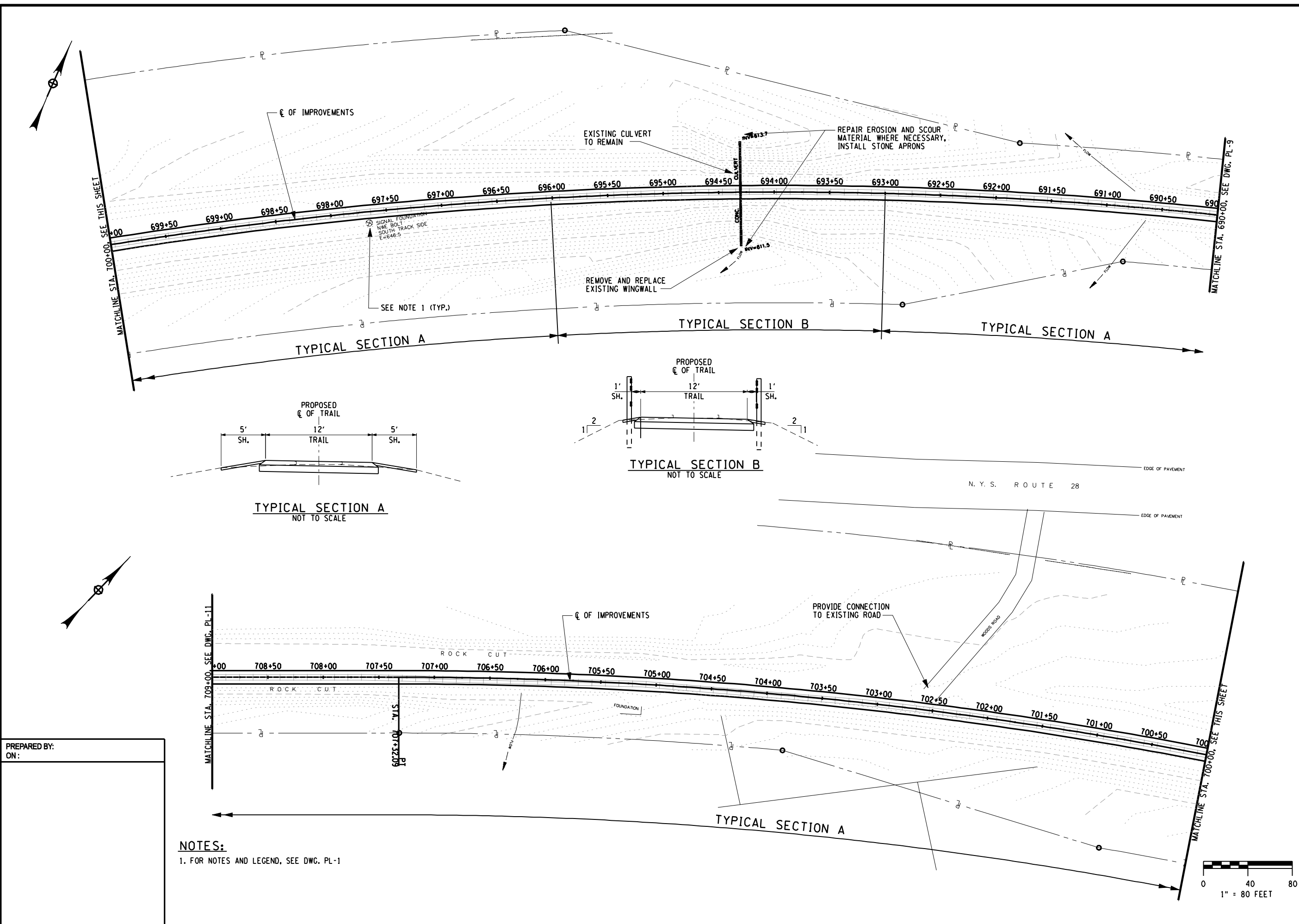

NO. DATE BY REVISION	
 <b>OPEN SPACE INSTITUTE</b>	
 <b>Barton &amp; Loguidice, D.P.C.</b>	
UNAUTHORIZED ALTERATION OR ADDITION TO THIS DRAWING IS A VIOLATION OF THE NEW YORK STATE EDUCATION LAW ARTICLE 145 SECTION 7209	
CATSKILL MOUNTAIN RAIL TRAIL ASHOKAN SECTION	OPEN SPACE INSTITUTE
ULSTER COUNTY	ALTERNATIVE 1A
GENERAL PLAN 10	
SCALE: 1" = 80	
DATE ISSUED: 02/2015	
DRAWING PL - 10	

FILE NAME = I:\mstr\_projects\1600\1653\002\001 - cmt phase 2\mstr\design report\1653\002 PL 11.dgn  
 DATE = 2/25/2015  
 TIME = 3:51:35 PM

L:\MicroStation\Workspace\Pilot\NYSDOT\SITE\_NYSDOT\_SIZE\_B.tbl  
 L:\MicroStation\Workspace\Pilot\NYSDOT\NYSDOT.LJ5000.B.04.00a.plt

DESIGNED BY \_\_\_\_\_ CHECKED BY \_\_\_\_\_  
 DRAFTED BY \_\_\_\_\_

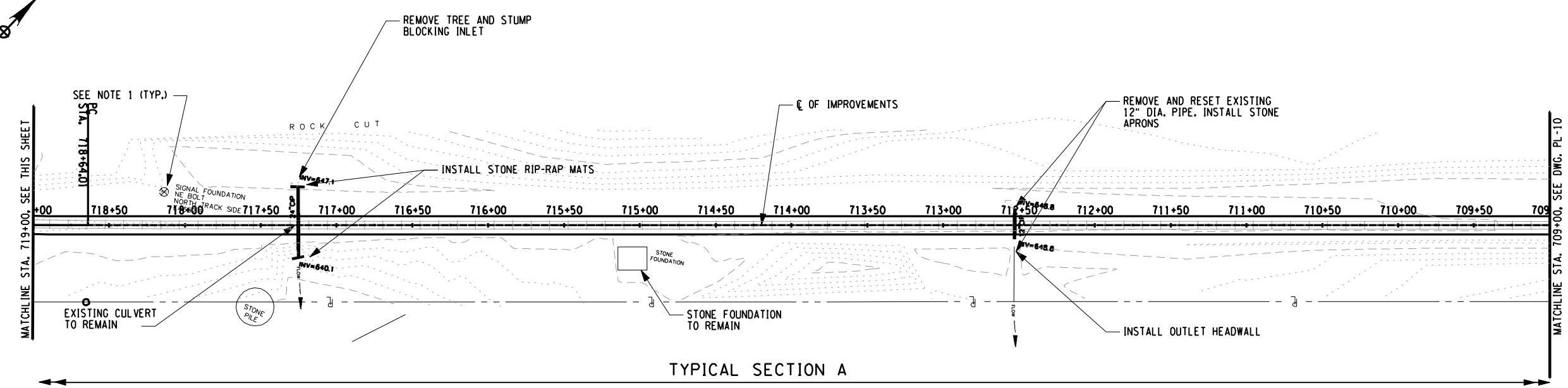
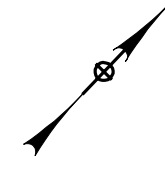

TYPICAL SECTION A

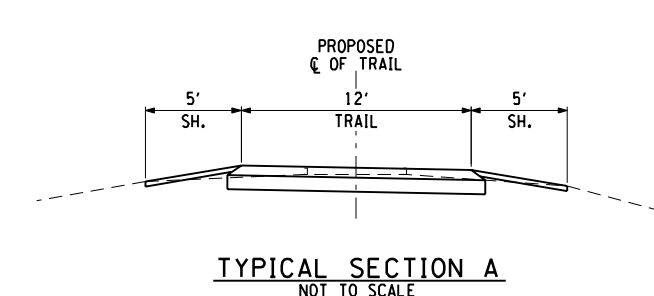

TYPICAL SECTION A  
NOT TO SCALE

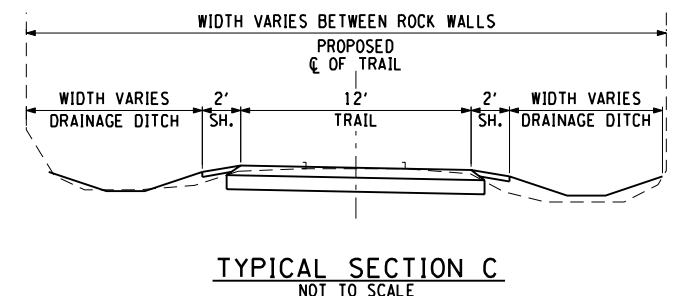

TYPICAL SECTION C  
NOT TO SCALE

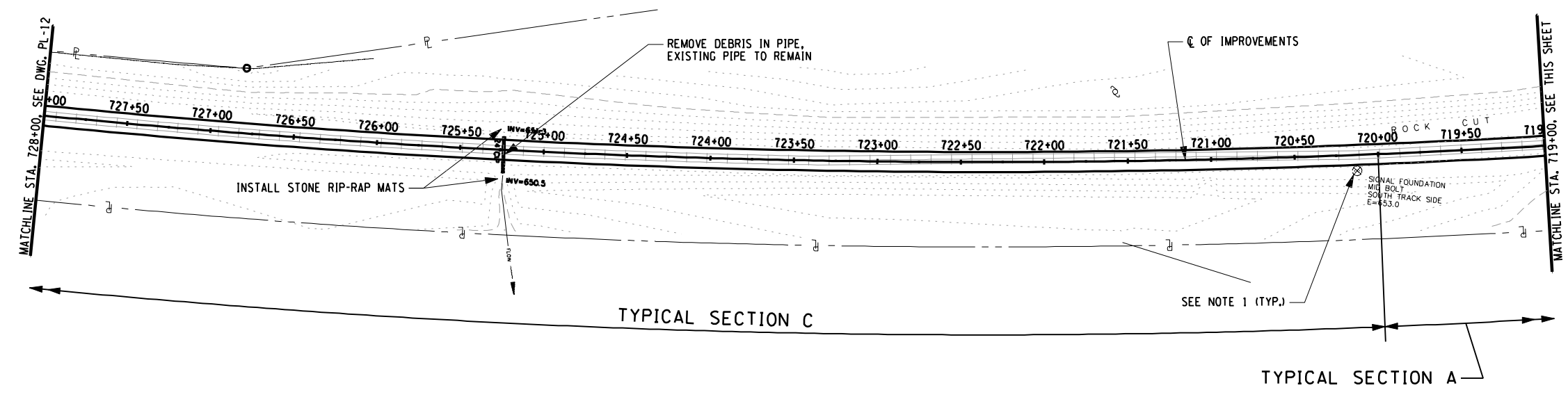
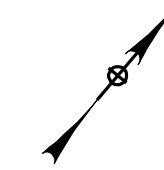

TYPICAL SECTION C

TYPICAL SECTION A

NOTES:  
 1. FOR NOTES AND LEGEND, SEE DWG. PL-1

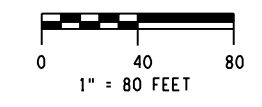

 <b>OPEN SPACE INSTITUTE</b>	<b>BL</b> <small>Barton &amp; Loguidice, D.P.C.</small>	<small>UNAUTHORIZED ALTERATION OR ADDITION TO THIS DRAWING IS A VIOLATION OF THE NEW YORK STATE EDUCATION LAW ARTICLE 148 SECTION 7209</small>	<b>CATSKILL MOUNTAIN RAIL TRAIL ASHOKAN SECTION</b>	<b>OPEN SPACE INSTITUTE</b>	<b>ULSTER COUNTY</b>	<b>ALTERNATIVE 1 A</b>	
<b>GENERAL PLAN 11</b>							
<small>SCALE: 1" = 80</small>							
<small>DATE ISSUED: 02/2015</small>							
<small>DRAWING PL - 11</small>							
<small>NO. DATE BY REVISION</small>							

XX

L:\MicroStation\Workspace\Plot\NYSDOT\NYSDOT SITE B.tbl  
 L:\MicroStation\Workspace\Plot\NYSDOT\NYSDOT.LJ5000.B.04.00b.plt

FILE NAME = I:\mstr\_projects\1600\1653\002\001 - cmrt phase 2\mstr\design report\1653\002 PL 12.dgn  
 DATE = 2/25/2015  
 TIME = 3:51:37 PM

IN CHARGE OF \_\_\_\_\_  
 DESIGNED BY \_\_\_\_\_  
 CHECKED BY \_\_\_\_\_  
 DRAFTED BY \_\_\_\_\_  
 CHECKED BY \_\_\_\_\_

PREPARED BY:  
 ON:

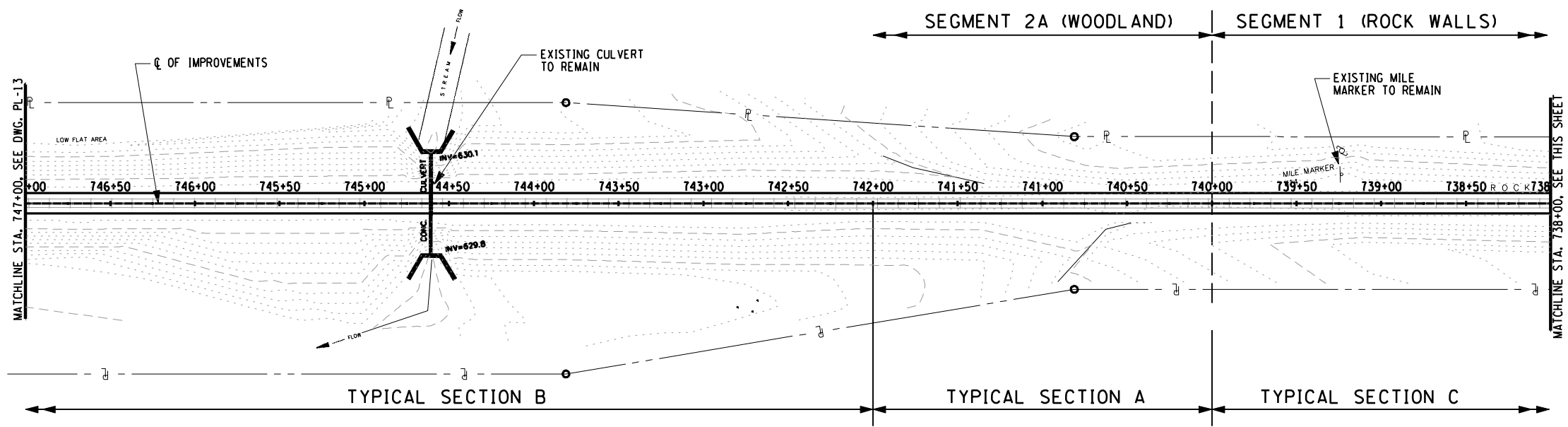
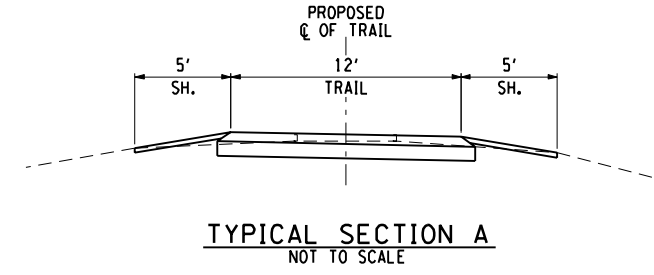
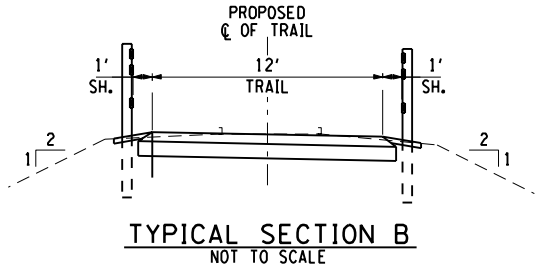
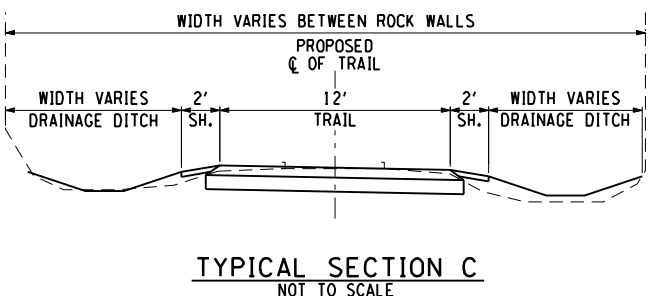
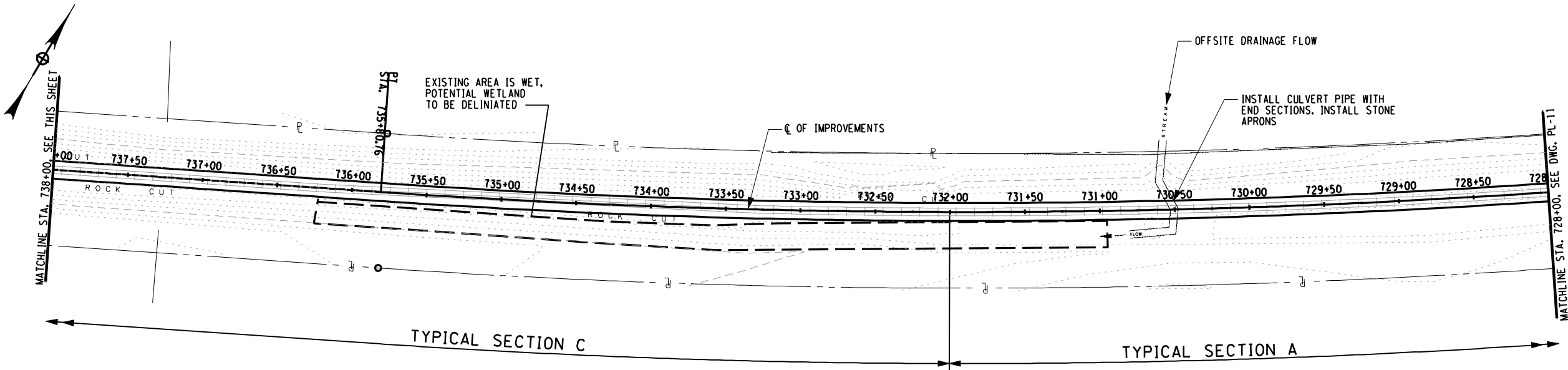

NOTES:  
 1. FOR NOTES AND LEGEND, SEE DWG. PL-1

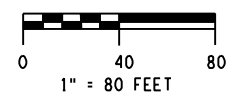

NO.	DATE	BY	REVISION



**Barton**  
**B&L**  
 oguicce, D.P.C.

UNAUTHORIZED ALTERATION OR ADDITION TO THIS DRAWING IS A VIOLATION OF THE NEW YORK STATE EDUCATION LAW ARTICLE 148 SECTION 7209

CATSKILL MOUNTAIN RAIL TRAIL  
 ASHOKAN SECTION

OPEN SPACE INSTITUTE

ULSTER COUNTY

ALTERNATIVE 1A

GENERAL PLAN 12

SCALE: 1" = 80

DATE ISSUED: 02/2015

DRAWING PL - 12

XX



L:\MicroStation\Workspace\Pilot\NYSDOT\SITE\NYSDOT\_SIZE\_B.tbl  
 L:\MicroStation\Workspace\Pilot\NYSDOT\NYSDOT.LJ5000.B.04.00a.plt

FILE NAME = I:\mstr\_projects\1600\1653\002\001 - cmt phase 2\mstr\design report\1653\002 PL 13.dgn  
 DATE = 2/25/2015  
 TIME = 3:51:39 PM

IN CHARGE OF \_\_\_\_\_ DESIGNED BY \_\_\_\_\_ CHECKED BY \_\_\_\_\_ DRAFTED BY \_\_\_\_\_ CHECKED BY \_\_\_\_\_

PREPARED BY:  
 ON:

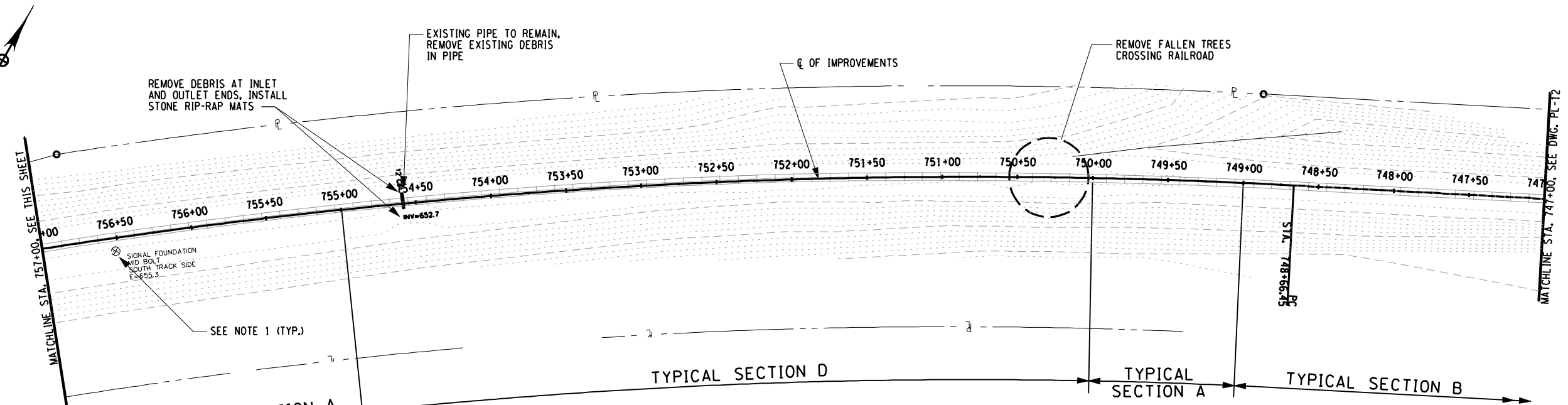
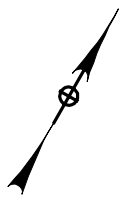

TYPICAL SECTION A

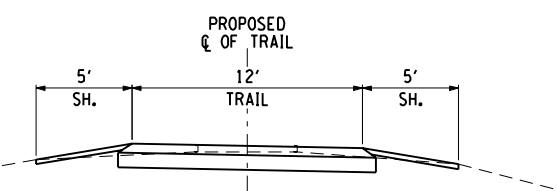

TYPICAL SECTION A  
 NOT TO SCALE

TYPICAL SECTION D

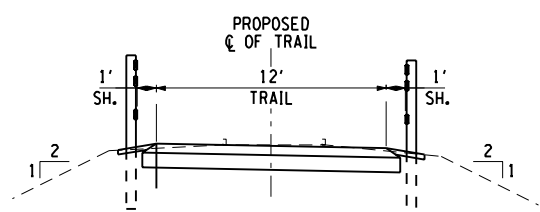

TYPICAL SECTION D  
 NOT TO SCALE

TYPICAL SECTION A

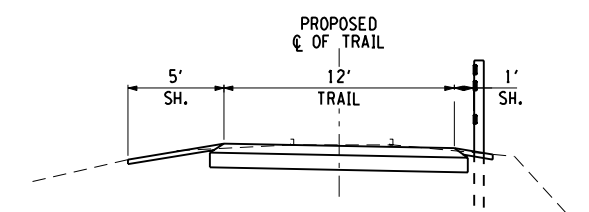

TYPICAL SECTION A  
 NOT TO SCALE

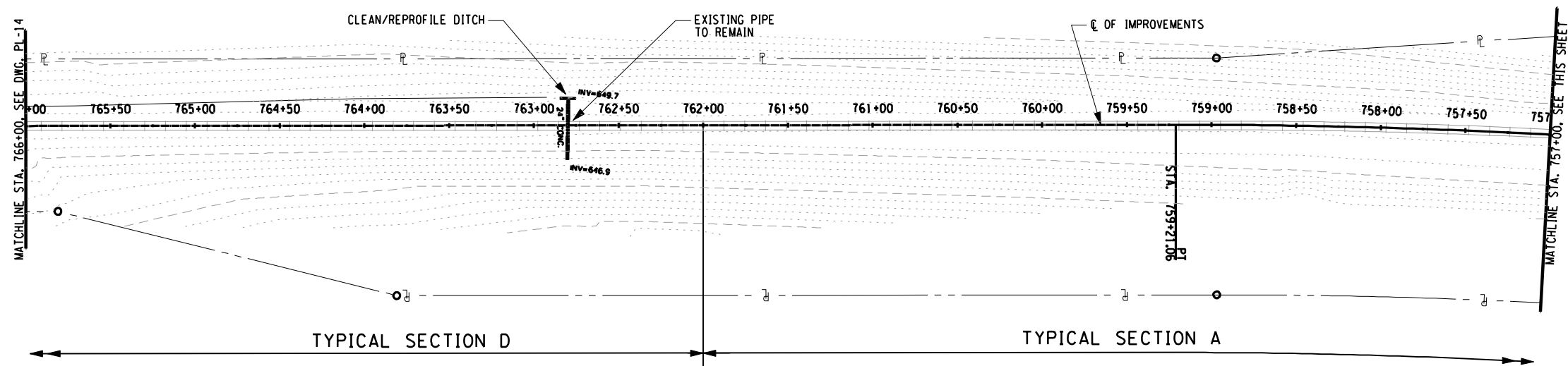
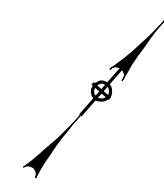

TYPICAL SECTION D

TYPICAL SECTION A

NOTES:  
 1. FOR NOTES AND LEGEND, SEE DWG. PL-1

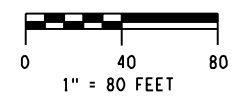

NO.	DATE	BY	REVISION

OPEN SPACE INSTITUTE

**Barton & Loguidice, D.P.C.**

UNAUTHORIZED ALTERATION OR ADDITION TO THIS DRAWING IS A VIOLATION OF THE NEW YORK STATE EDUCATION LAW ARTICLE 145 SECTION 7209

CATSKILL MOUNTAIN RAIL TRAIL  
 ASHOKAN SECTION

OPEN SPACE INSTITUTE

ULSTER COUNTY

ALTERNATIVE 1A

GENERAL PLAN 13

SCALE: 1:80

DATE ISSUED: 02/2015

DRAWING PL-13

XX

L:\MicroStation\Workspace\Plot\NYSOOT\NYSOOT\_SITE\_B.tbl  
 L:\MicroStation\Workspace\Plot\NYSOOT\NYSOOT.LJ5000.B.04.009.plt

FILE NAME = I:\mstr\_projects\1600\1653\002\001 - cmt phase 2\mstr\design report\1653\002 PL 14.dgn  
 DATE = 2/25/2015  
 TIME = 3:51:41 PM

IN CHARGE OF \_\_\_\_\_ DESIGNED BY \_\_\_\_\_ CHECKED BY \_\_\_\_\_ DRAFTED BY \_\_\_\_\_ CHECKED BY \_\_\_\_\_

PREPARED BY:  
 ON:

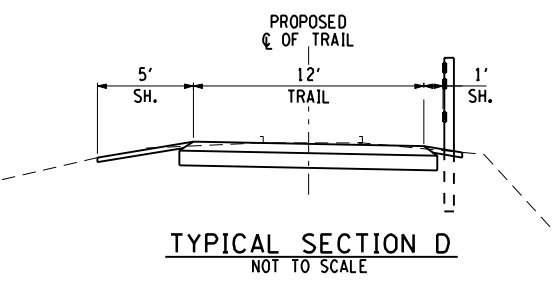
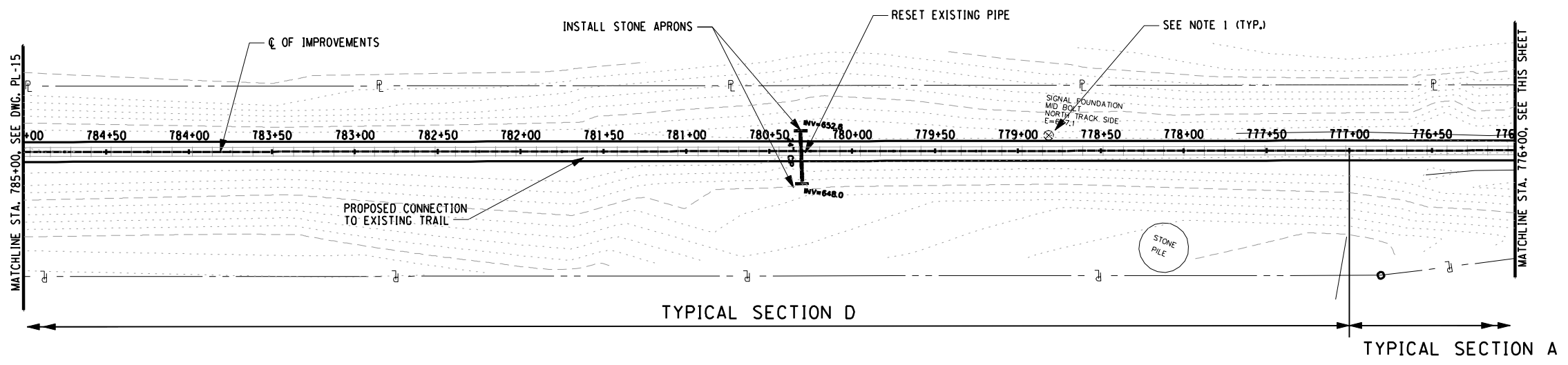
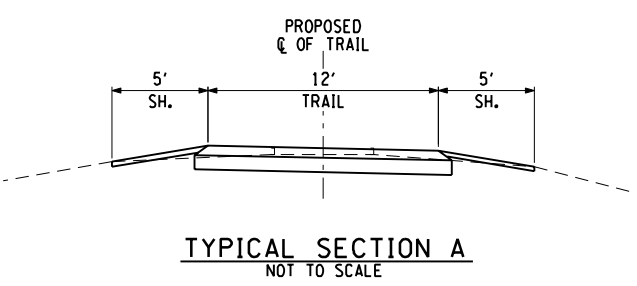
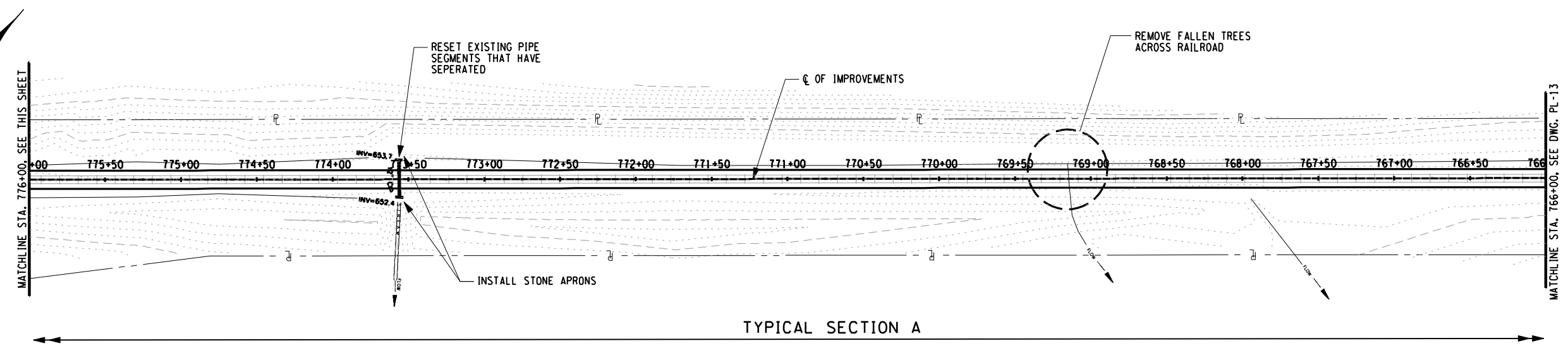

NOTES:  
 1. FOR NOTES AND LEGEND, SEE DWG. PL-1

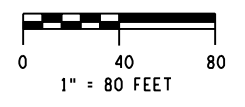

NO. DATE BY REVISION	
<small>UNAUTHORIZED ALTERATION OR ADDITION TO THIS DRAWING IS A VIOLATION OF THE NEW YORK STATE EDUCATION LAW ARTICLE 145 SECTION 7209</small>	
CATSKILL MOUNTAIN RAIL TRAIL ASHOKAN SECTION	ALTERNATIVE 1 A
OPEN SPACE INSTITUTE	ULSTER COUNTY
GENERAL PLAN 14	
SCALE: 1" = 80'	
DATE ISSUED: 02/2015	
DRAWING PL - 14	

XX

cmh  
 L:\MicroStation\Workspace\Plot\NYSDOT\SITE\_NYSDOT\_SIZE\_B.tbl  
 L:\MicroStation\Workspace\Plot\NYSDOT\NYSDOT.LJ5000.B.04.00a.plt

FILE NAME = I:\mstr\_projects\1600\1653.002.001 - cmt phase 2\mstr\design report\1653.002 PL 15.dgn  
 DATE = 2/25/2015  
 TIME = 3:51:43 PM

IN CHARGE OF \_\_\_\_\_ DESIGNED BY \_\_\_\_\_ CHECKED BY \_\_\_\_\_ DRAFTED BY \_\_\_\_\_ CHECKED BY \_\_\_\_\_

PREPARED BY:  
 ON:

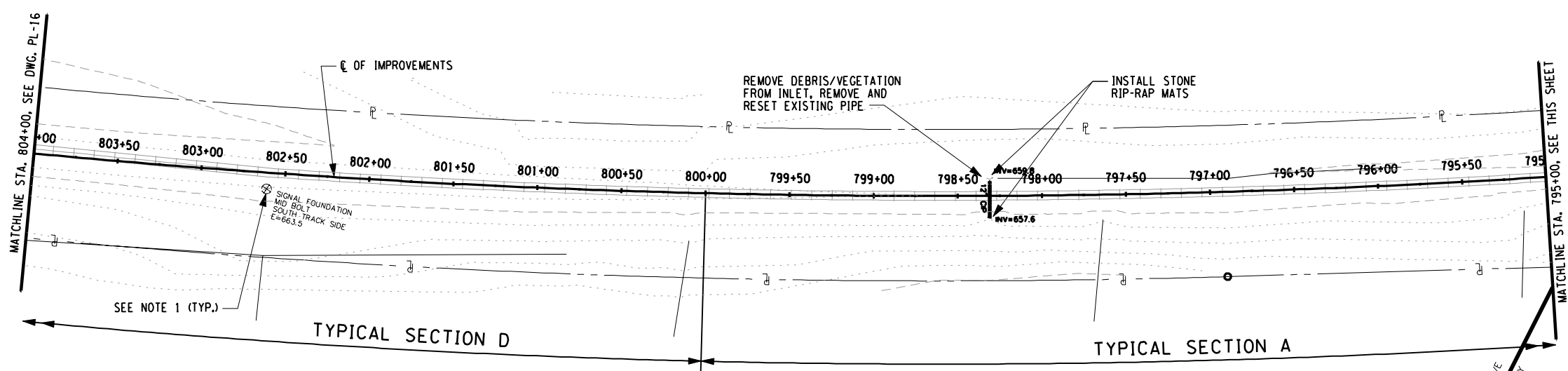
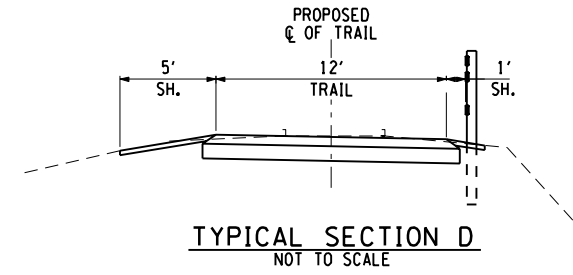
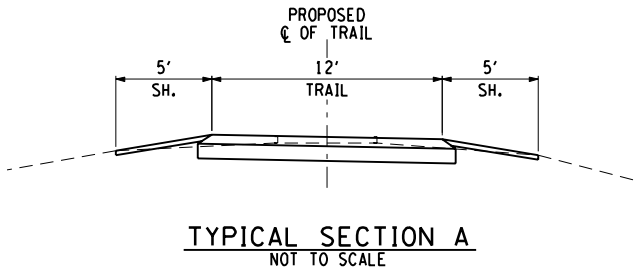
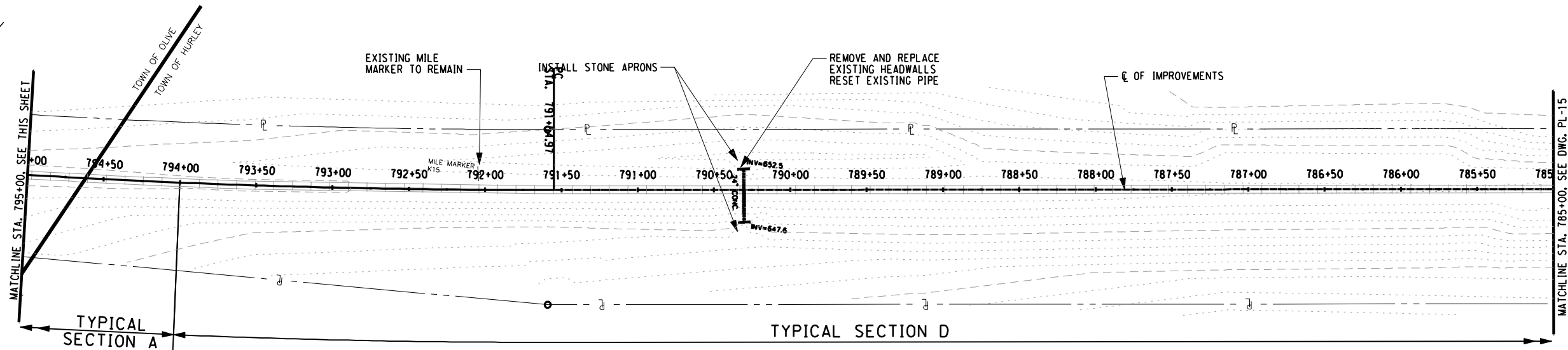
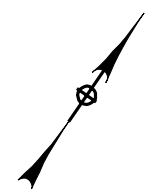
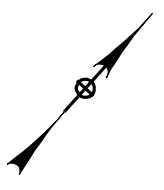

**NOTES:**  
 1. FOR NOTES AND LEGEND, SEE DWG. PL-1



NO.	DATE	BY	REVISION



**Barton**  
**B&E** **Loguidice, D.P.C.**  
 UNAUTHORIZED ALTERATION OR ADDITION TO THIS DRAWING IS A VIOLATION OF THE NEW YORK STATE EDUCATION LAW ARTICLE 148 SECTION 7209

CATSKILL MOUNTAIN RAIL TRAIL  
 ASHOKAN SECTION  
 OPEN SPACE INSTITUTE  
 ULSTER COUNTY  
 ALTERNATIVE 1A

GENERAL PLAN 15  
 SCALE: 1" = 80'  
 DATE ISSUED: 02/2015  
 DRAWING PL - 15

XX

FILE NAME = I:\mstr\_projects\1600\1653.002\001 - cmt phase 2\mstr\design report\1653.002 PL 16.dgn  
 DATE = 2/25/2015  
 TIME = 3:51:45 PM

cmh  
 L:\MicroStation\Workspace\Plot\NYSOOT\NYSOOT SITE B.tbl  
 L:\MicroStation\Workspace\Plot\NYSOOT\NYSOOT.LJ5000.B.04.009.plt

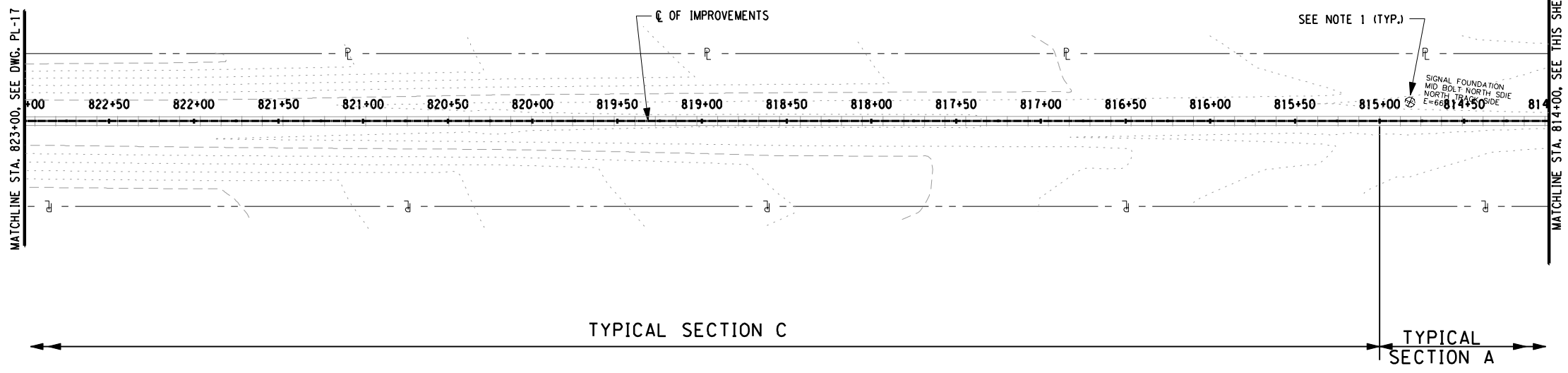
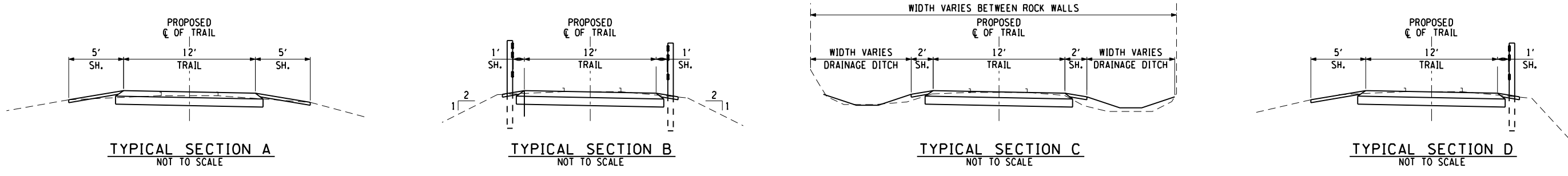
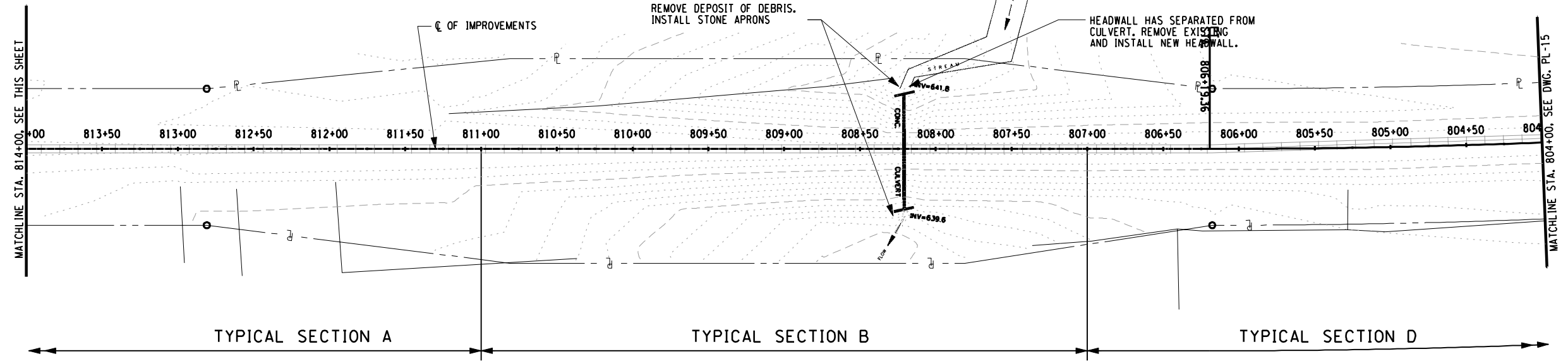
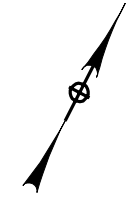

DESIGNED BY \_\_\_\_\_ CHECKED BY \_\_\_\_\_ DRAFTED BY \_\_\_\_\_ IN CHARGE OF \_\_\_\_\_

PREPARED BY:  
 ON:

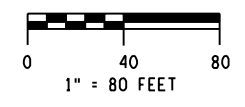

**NOTES:**  
 1. FOR NOTES AND LEGEND, SEE DWG. PL-1



NO. DATE BY REVISION	
 <b>OPEN SPACE INSTITUTE</b>	
 <b>Barton &amp; Loguidice, D.P.C.</b>	
<small>UNAUTHORIZED ALTERATION OR ADDITION TO THIS DRAWING IS A VIOLATION OF THE NEW YORK STATE EDUCATION LAW ARTICLE 148 SECTION 7209</small>	
CATSKILL MOUNTAIN RAIL TRAIL ASHOKAN SECTION	OPEN SPACE INSTITUTE
ULSTER COUNTY	ALTERNATIVE 1 A
GENERAL PLAN 16	
SCALE: 1" = 80'	
DATE ISSUED: 02/2015	
DRAWING PL - 16	

L:\MicroStation\Workspace\Plot\NYSOOT\NYSOOT\_SITE\_B.tbl  
 L:\MicroStation\Workspace\Plot\NYSOOT\NYSOOT.LJ5000.B.04.009.plt

FILE NAME = I:\mstr\_projects\1600\1653\002\001 - cmrt phase 2\mstr\design report\1653\002 PL 17.dgn  
 DATE = 2/25/2015  
 TIME = 3:51:47 PM

IN CHARGE OF \_\_\_\_\_  
 DESIGNED BY \_\_\_\_\_  
 CHECKED BY \_\_\_\_\_  
 DRAFTED BY \_\_\_\_\_  
 CHECKED BY \_\_\_\_\_

PREPARED BY:  
 ON:

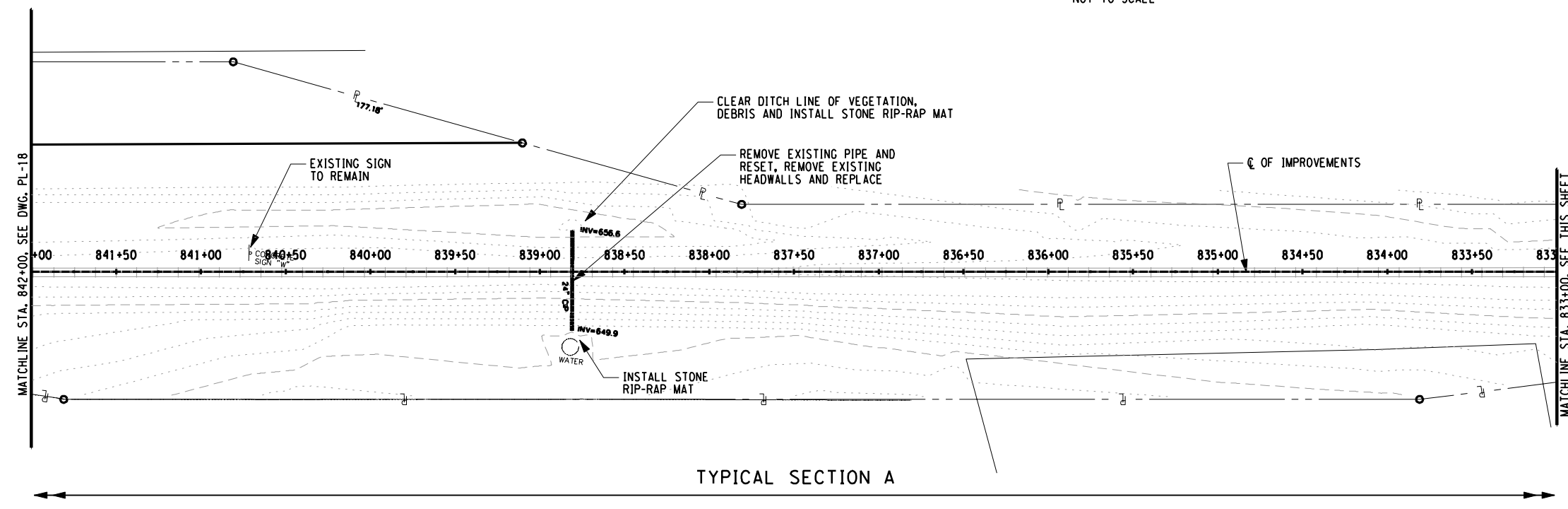
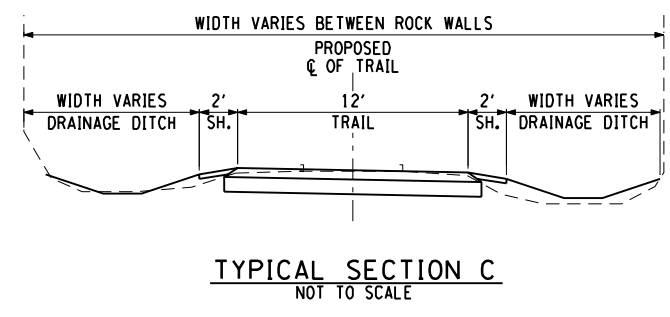
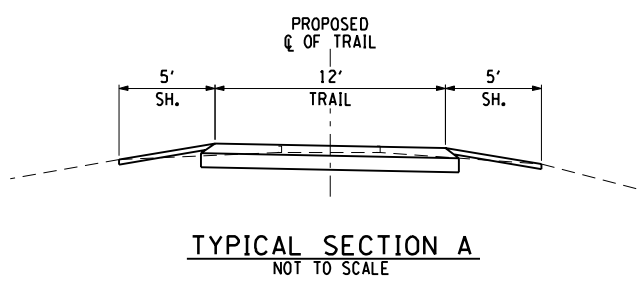
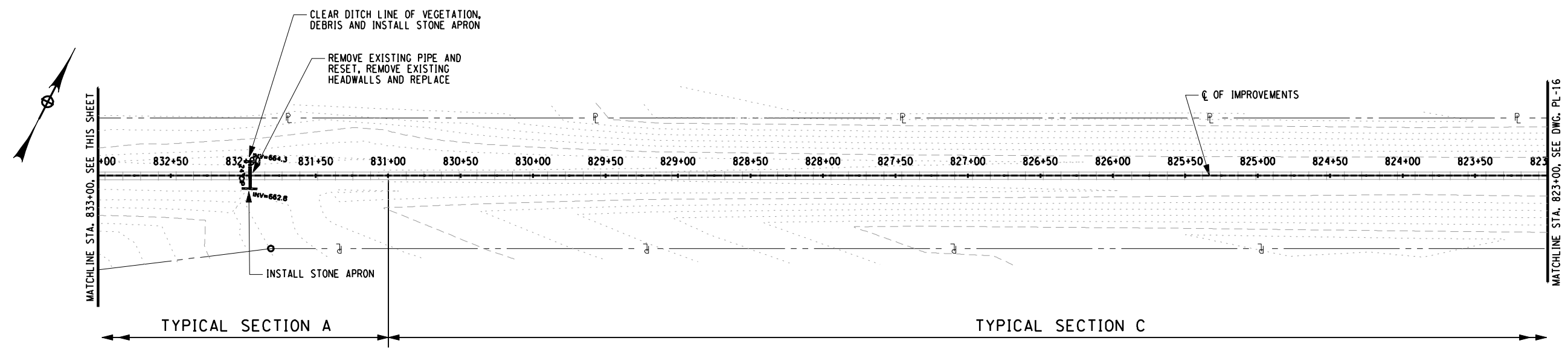

NOTES:  
 1. FOR NOTES AND LEGEND, SEE DWG. PL-1

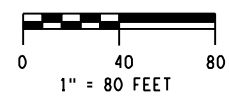

NO.	DATE	BY	REVISION



**Barton**  
**B&E**  
 ognice, D.P.C.

UNAUTHORIZED ALTERATION OR ADDITION TO THIS DRAWING IS A VIOLATION OF THE NEW YORK STATE EDUCATION LAW ARTICLE 145 SECTION 7209

CATSKILL MOUNTAIN RAIL TRAIL  
 ASHOKAN SECTION

OPEN SPACE INSTITUTE

ULSTER COUNTY

ALTERNATIVE 1A

GENERAL PLAN 17

SCALE: 1" = 80

DATE ISSUED: 02/2015

DRAWING PL - 17

XX

cmh  
 L:\MicroStation\Workspace\Plot\NYSDOT\NYSDOT SITE SIZE.B.tbl  
 L:\MicroStation\Workspace\Plot\NYSDOT\NYSDOT.LJ5000.B.04.009.plt

FILE NAME = I:\mstr\_projects\1600\1653.002.001 - cmrt phase 2\mstr\design report\1653.002 PL 18.dgn  
 DATE = 2/25/2015  
 TIME = 3:51:50 PM

IN CHARGE OF \_\_\_\_\_  
 DESIGNED BY \_\_\_\_\_  
 CHECKED BY \_\_\_\_\_  
 DRAFTED BY \_\_\_\_\_  
 CHECKED BY \_\_\_\_\_

PREPARED BY:  
 ON:

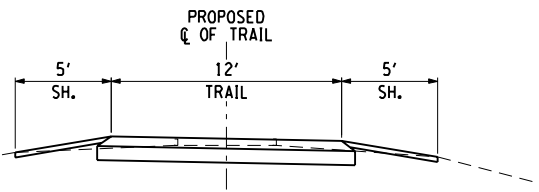
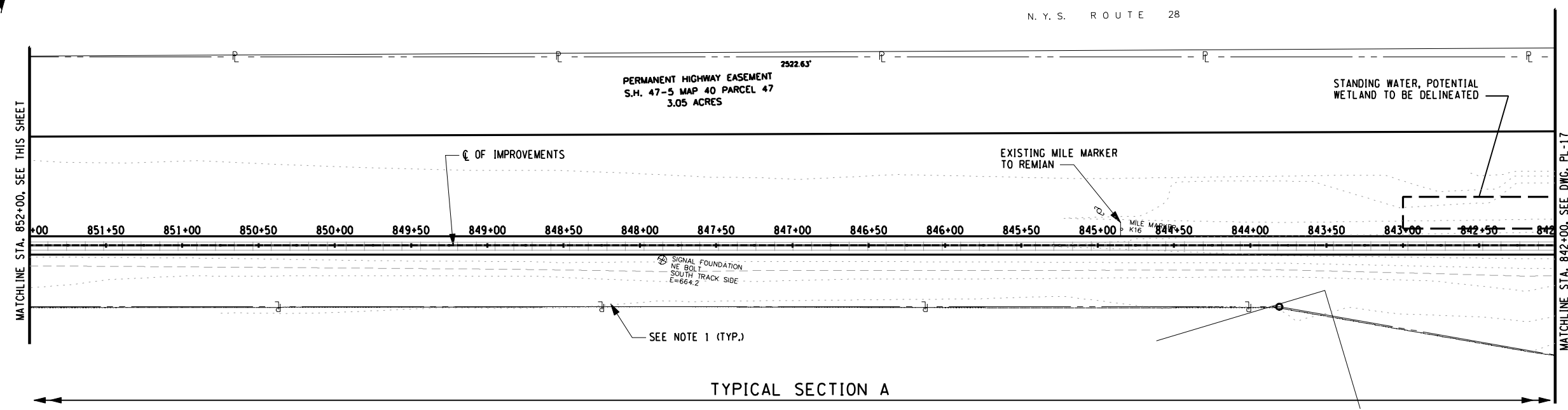
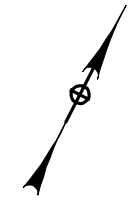
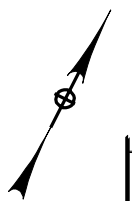

TYPICAL SECTION A  
 NOT TO SCALE

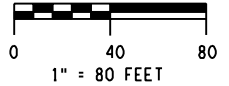
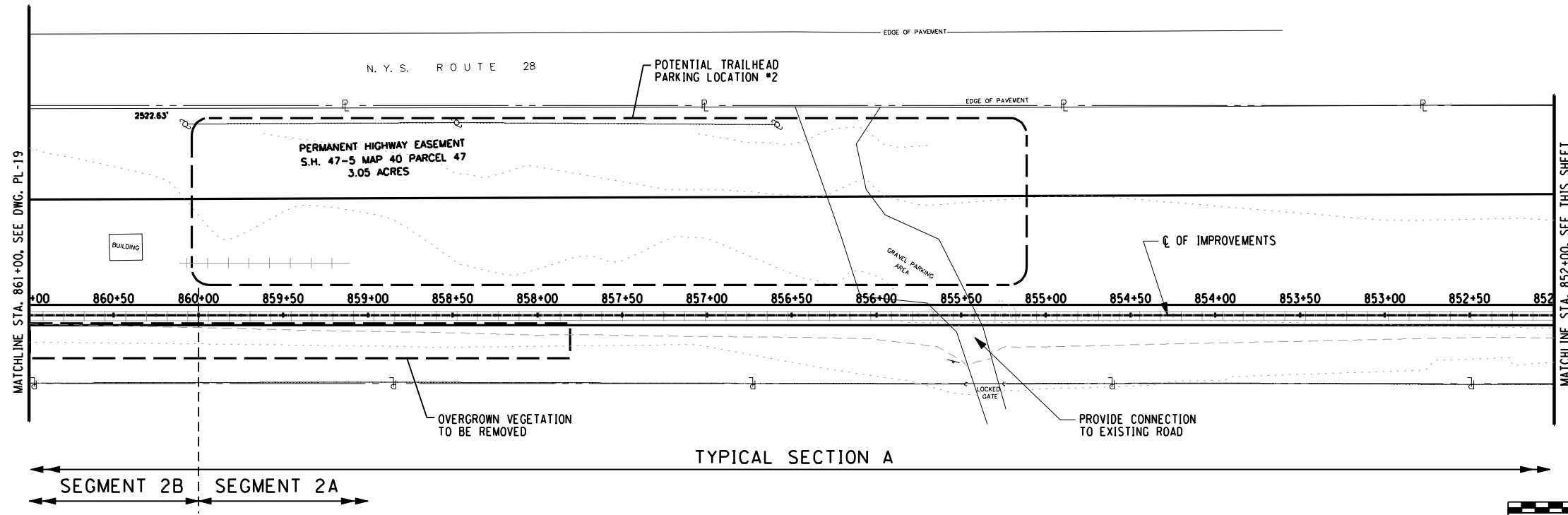

NOTES:  
 1. FOR NOTES AND LEGEND, SEE DWG. PL-1

NO.	DATE	BY	REVISION



**Barton**  
**B&E**  
 ognidice, D.P.C.  
 UNAUTHORIZED ALTERATION OR ADDITION TO THIS  
 DRAWING IS A VIOLATION OF THE NEW YORK STATE  
 EDUCATION LAW ARTICLE 148 SECTION 7209

CATSKILL MOUNTAIN RAIL TRAIL  
 ASHOKAN SECTION  
 OPEN SPACE INSTITUTE  
 ULSTER COUNTY  
 ALTERNATIVE 1A

GENERAL  
 PLAN 18  
 SCALE: 1" = 80'  
 DATE ISSUED: 02/2015  
 DRAWING  
 PL - 18

XX

cmh  
 L:\MicroStation\Workspace\Plot\NYSDOT\NYSDOT SITE\_NYSDOT\_SIZE\_B.tbl  
 L:\MicroStation\Workspace\Plot\NYSDOT\NYSDOT.LJ5000.B.04.00a.plt

FILE NAME = I:\mstr\_projects\1600\1653\002\001 - cmt phase 2\mstr\design report\1653\002 PL 19.dgn  
 DATE = 2/25/2015  
 TIME = 3:51:52 PM

IN CHARGE OF \_\_\_\_\_  
 DESIGNED BY \_\_\_\_\_  
 CHECKED BY \_\_\_\_\_  
 DRAFTED BY \_\_\_\_\_

PREPARED BY:  
 ON:

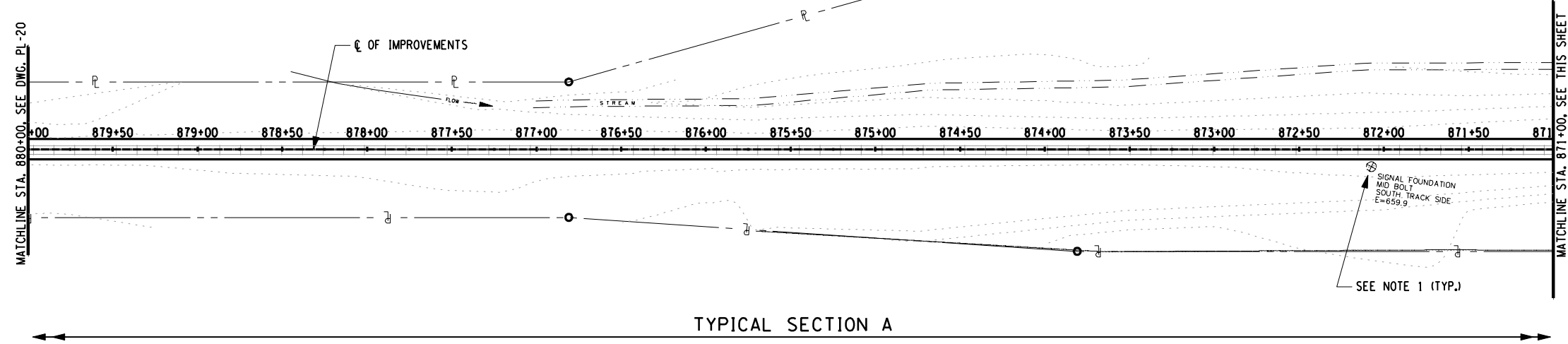
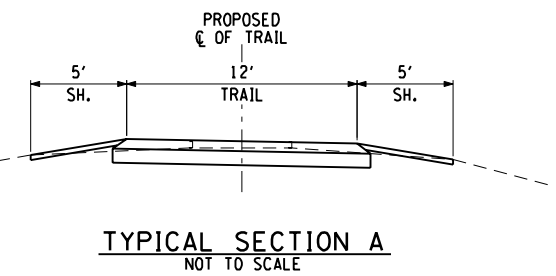
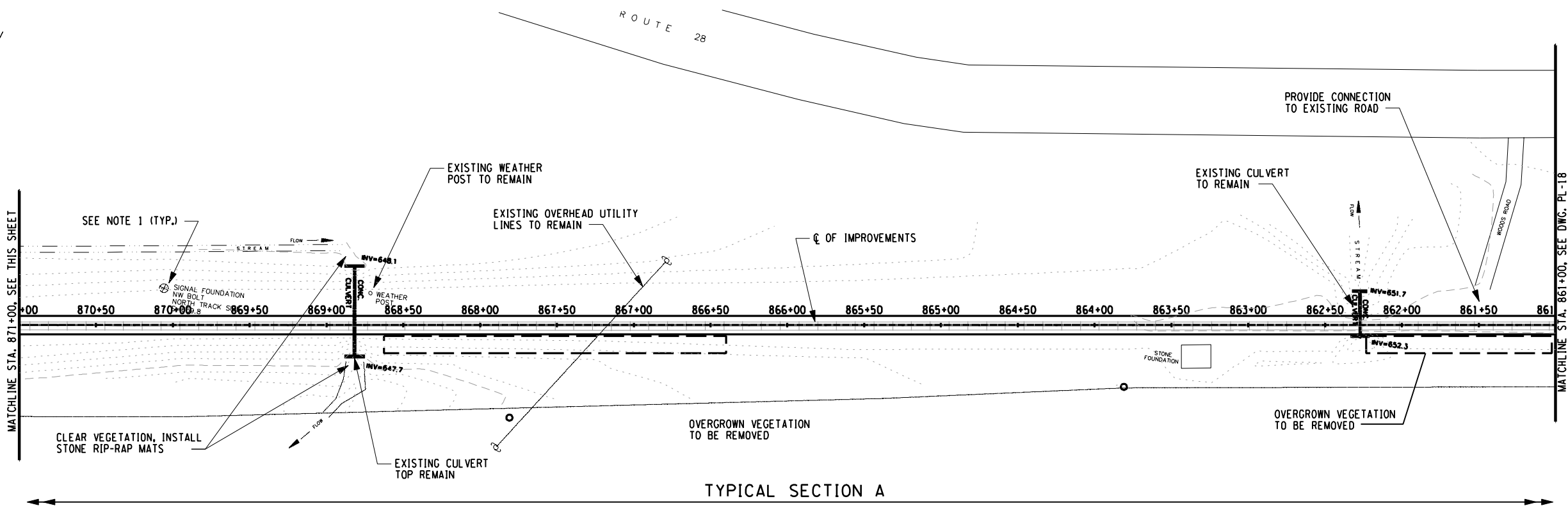

**NOTES:**  
 1. FOR NOTES AND LEGEND, SEE DWG. PL-1

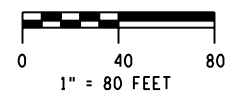

NO. DATE BY REVISION	
 <b>OPEN SPACE INSTITUTE</b>	
 <b>Barton B&amp;Loguidice, D.P.C.</b>	
UNAUTHORIZED ALTERATION OR ADDITION TO THIS DRAWING IS A VIOLATION OF THE NEW YORK STATE EDUCATION LAW ARTICLE 148 SECTION 7209	
CATSKILL MOUNTAIN RAIL TRAIL ASHOKAN SECTION	ALTERNATIVE 1A
OPEN SPACE INSTITUTE	ULSTER COUNTY
GENERAL PLAN 19	
SCALE: 1" = 80'	
DATE ISSUED: 02/2015	
DRAWING PL - 19	

XX

cmh  
 L:\MicroStation\Workspace\Plot\NYSDOT\SITE\_NYSDOT\_SIZE\_B.tbl  
 L:\MicroStation\Workspace\Plot\NYSDOT\NYSDOT\_LL5000.B.04.009.plt

FILE NAME = I:\mstr\_projects\1600\1653.002.001 - cmt phase 2\mstr\design report\1653.002 PL 20.dgn  
 DATE = 2/25/2015  
 TIME = 3:51:54 PM

IN CHARGE OF \_\_\_\_\_ DESIGNED BY \_\_\_\_\_ CHECKED BY \_\_\_\_\_ DRAFTED BY \_\_\_\_\_ CHECKED BY \_\_\_\_\_

PREPARED BY:  
 ON:

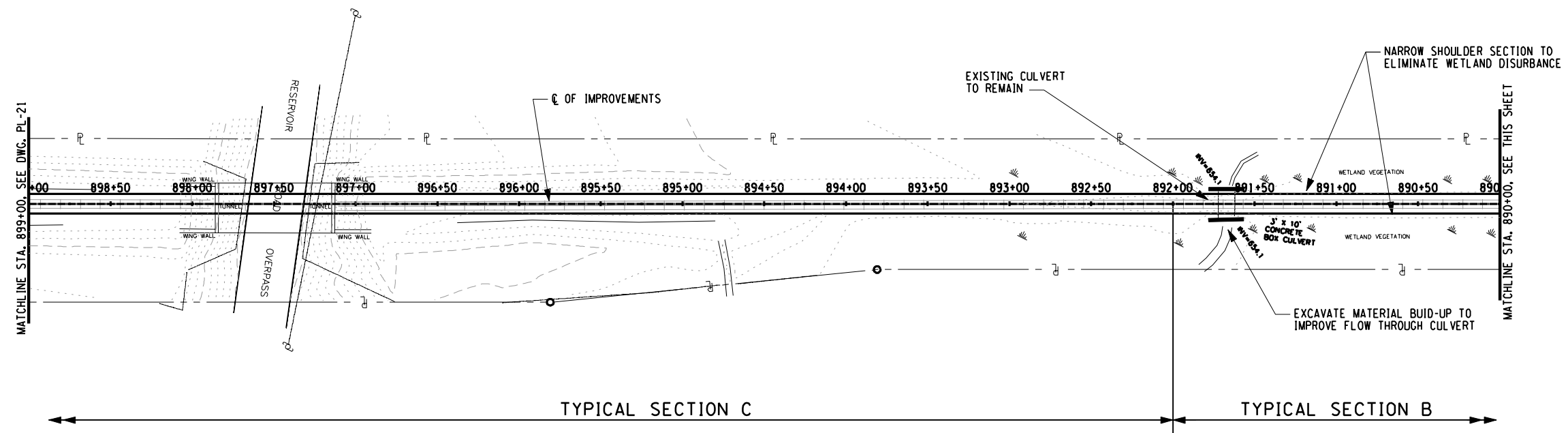
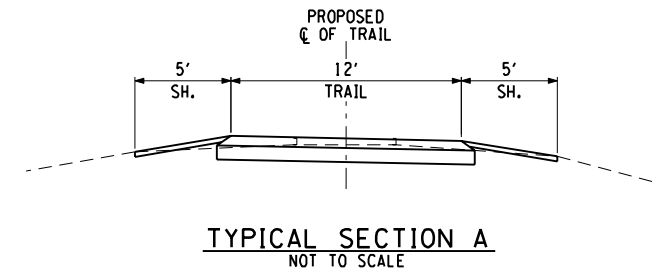
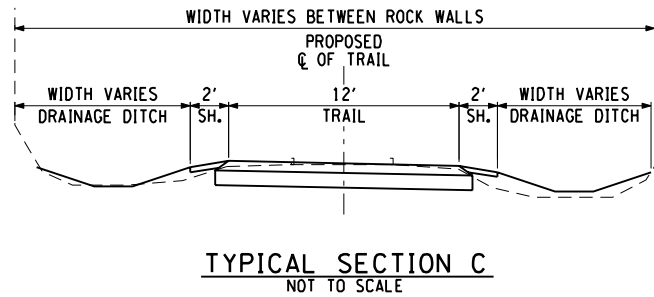
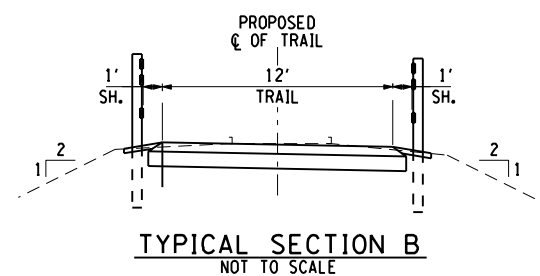
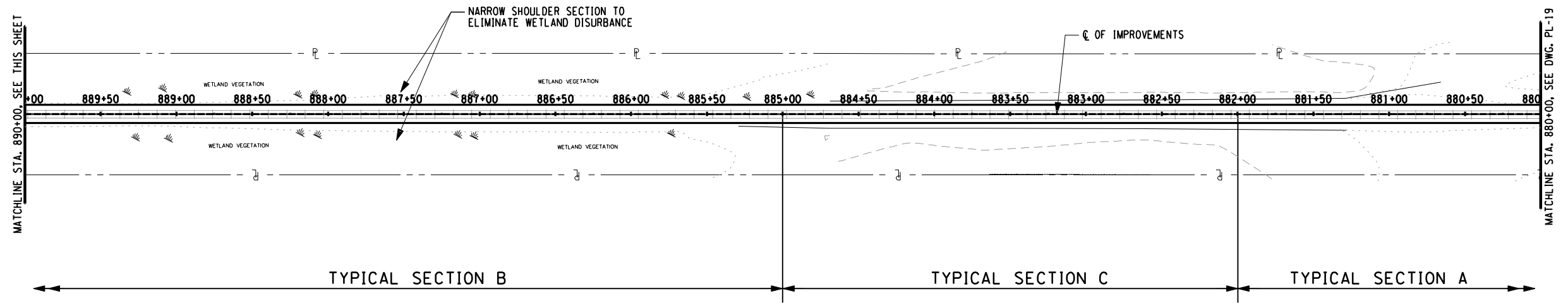

**NOTES:**  
 1. FOR NOTES AND LEGEND, SEE DWG. PL-1

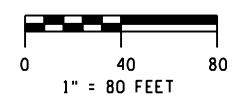

NO.	DATE	BY	REVISION



**Barton**  
**B&L**  
 oguice, D.P.C.

UNAUTHORIZED ALTERATION OR ADDITION TO THIS DRAWING IS A VIOLATION OF THE NEW YORK STATE EDUCATION LAW ARTICLE 145 SECTION 7209

CATSKILL MOUNTAIN RAIL TRAIL  
 ASHOKAN SECTION

OPEN SPACE INSTITUTE

ULSTER COUNTY

ALTERNATIVE 1A

GENERAL PLAN 20

SCALE: 1:80

DATE ISSUED: 02/2015

DRAWING PL - 20

XX



cmh  
 L:\MicroStation\Workspace\Plot\NYSDOT\NYSDOT SITE B.tbl  
 L:\MicroStation\Workspace\Plot\NYSDOT\NYSDOT.LJ5000.B.04.009.plt

FILE NAME = I:\mstr\_projects\1600\1653\002\001 - cmr phase 2\mstr\design report\1653\002 PL 21.dgn  
 DATE = 2/25/2015  
 TIME = 3:51:56 PM

IN CHARGE OF \_\_\_\_\_ DESIGNED BY \_\_\_\_\_ CHECKED BY \_\_\_\_\_ DRAFTED BY \_\_\_\_\_ CHECKED BY \_\_\_\_\_

PREPARED BY:  
 ON:

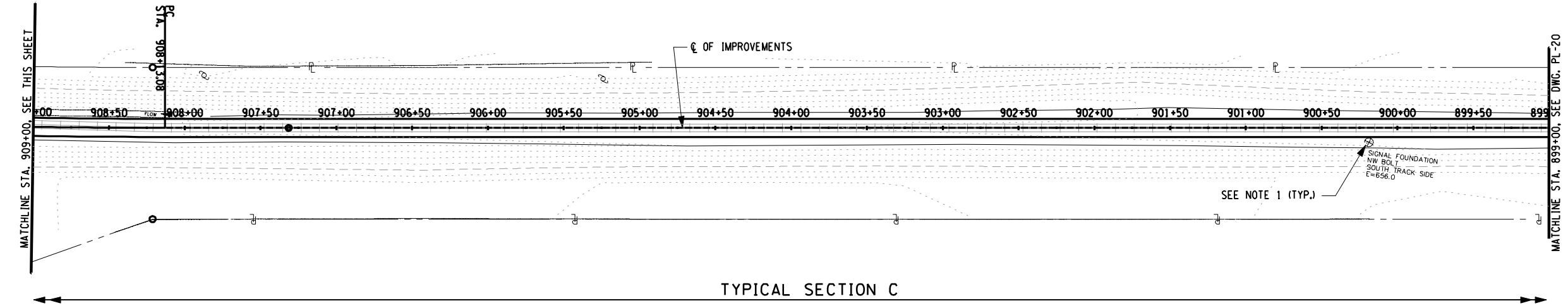
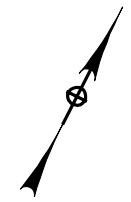

TYPICAL SECTION C

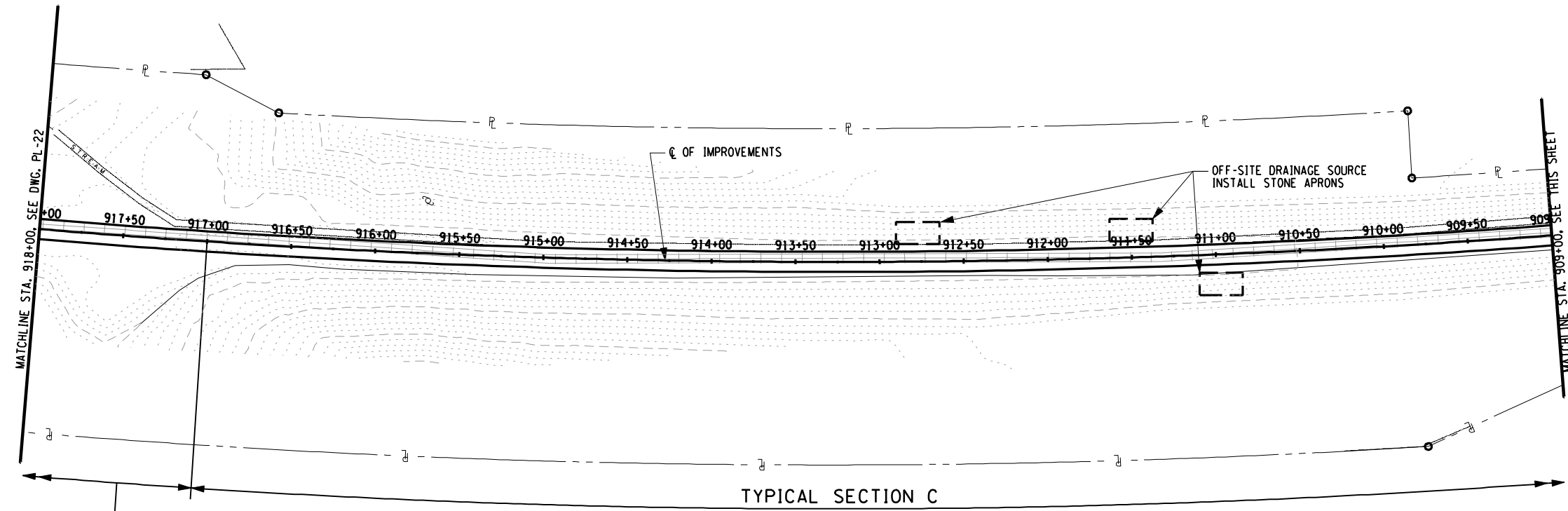
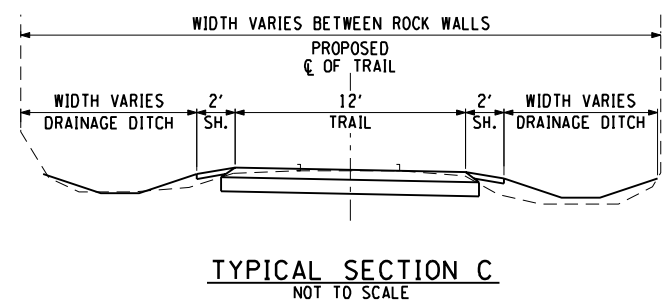
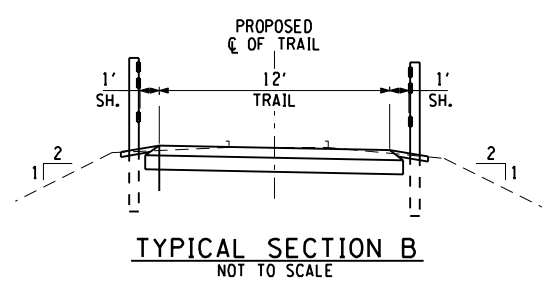

TYPICAL SECTION C

TYPICAL SECTION B

NOTES:  
 1. FOR NOTES AND LEGEND, SEE DWG. PL-1

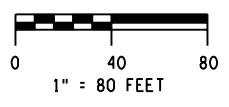

NO.	DATE	BY	REVISION



**Barton**  
**B&L**  
**oguidice, D.P.C.**  
 UNAUTHORIZED ALTERATION OR ADDITION TO THIS DRAWING IS A VIOLATION OF THE NEW YORK STATE EDUCATION LAW ARTICLE 148 SECTION 7209

CATSKILL MOUNTAIN RAIL TRAIL  
 ASHOKAN SECTION  
 OPEN SPACE INSTITUTE  
 ULSTER COUNTY  
 ALTERNATIVE 1 A

GENERAL PLAN 21  
 SCALE: 1" = 80'  
 DATE ISSUED: 02/2015  
 DRAWING PL - 21

XX

L:\MicroStation\Workspace\Plot\NYSOOT\NYSOOT\_SITE\_B.tbl  
 L:\MicroStation\Workspace\Plot\NYSOOT\NYSOOT.LJ5000.B.04.000.plt

FILE NAME = I:\mstr\_projects\1600\1653\002\001 - cmt phase 2\mstr\design report\1653\002 PL 22.dgn  
 DATE = 2/25/2015  
 TIME = 3:51:58 PM

IN CHARGE OF \_\_\_\_\_ DESIGNED BY \_\_\_\_\_ CHECKED BY \_\_\_\_\_ DRAFTED BY \_\_\_\_\_ CHECKED BY \_\_\_\_\_

PREPARED BY:  
 ON:

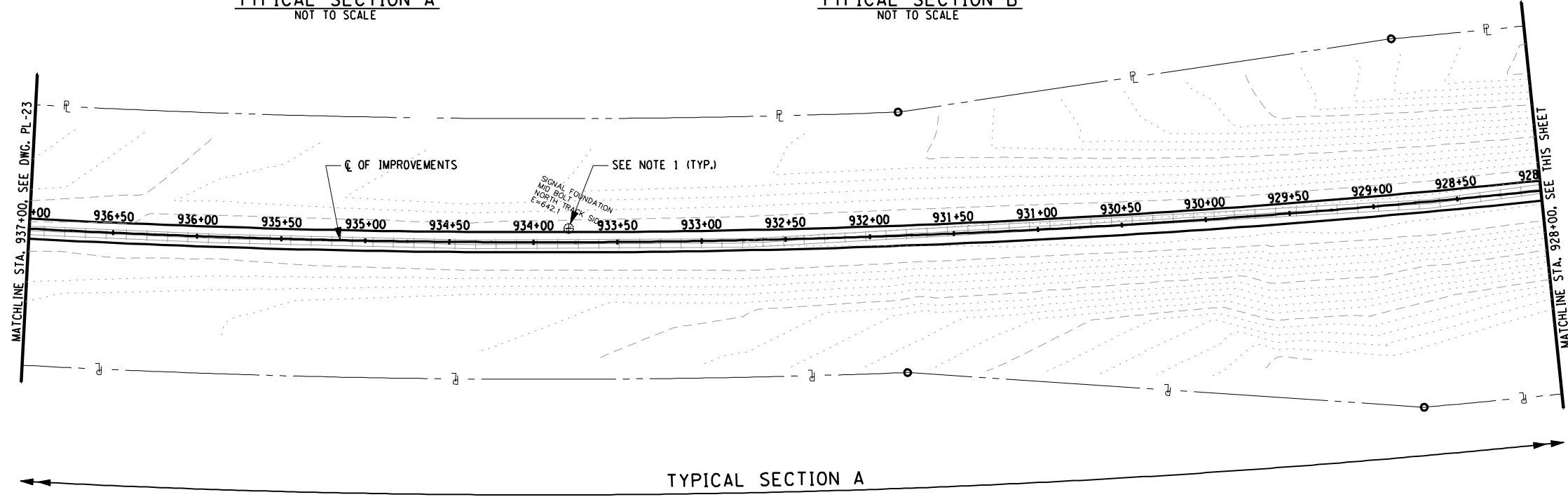
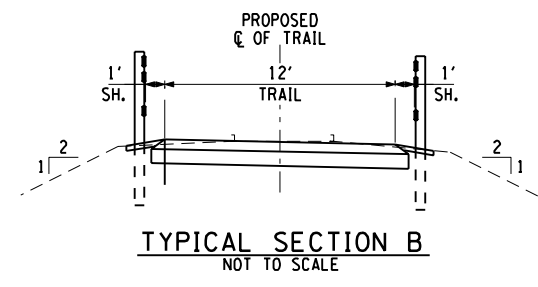
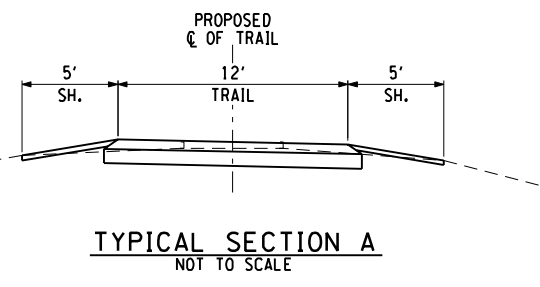
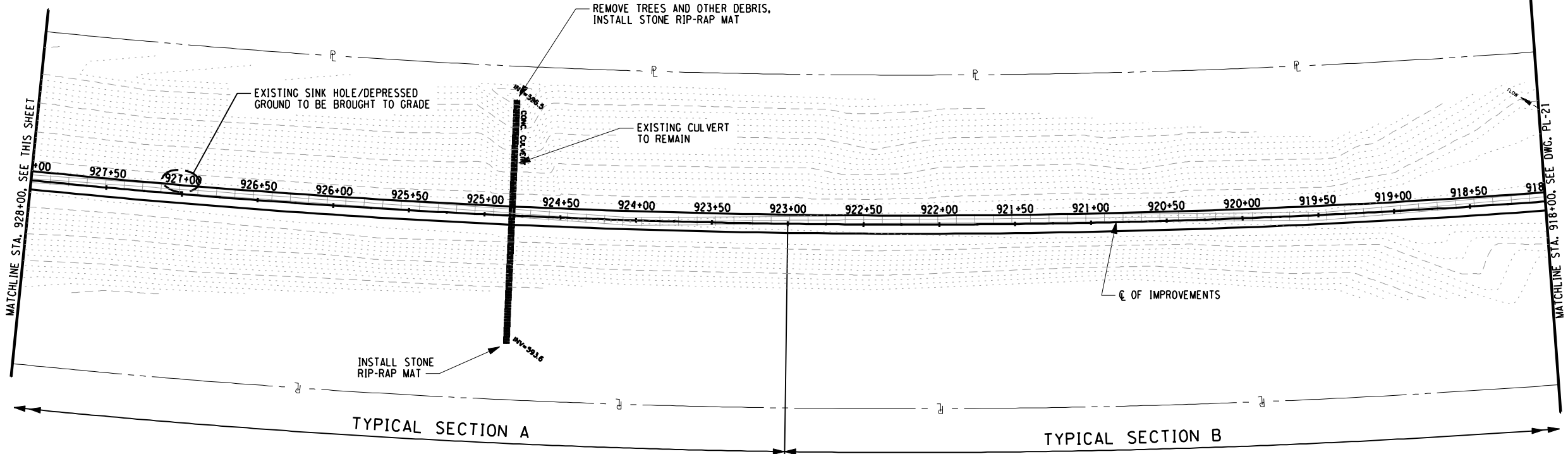

NOTES:  
 1. FOR NOTES AND LEGEND, SEE DWG. PL-1

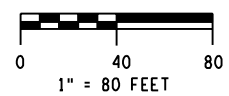

NO.	DATE	BY	REVISION



**Barton & Loguidice, D.P.C.**  
 UNAUTHORIZED ALTERATION OR ADDITION TO THIS DRAWING IS A VIOLATION OF THE NEW YORK STATE EDUCATION LAW ARTICLE 148 SECTION 7209

CATSKILL MOUNTAIN RAIL TRAIL  
 ASHOKAN SECTION  
 OPEN SPACE INSTITUTE  
 ULSTER COUNTY  
 ALTERNATIVE 1 A

GENERAL PLAN 22  
 SCALE: 1" = 80'  
 DATE ISSUED: 02/2015  
 DRAWING PL - 22

XX

cmh  
 L:\MicroStation\Workspace\Plot\NYSOOT\NYSOOT\_SITE\_B.tbl  
 L:\MicroStation\Workspace\Plot\NYSOOT\NYSOOT.LJ5000.B.04.009.plt

FILE NAME = I:\mstr\_projects\1600\1653\002\001 - cmt phase 2\mstr\design report\1653\002 PL 23.dgn  
 DATE = 2/25/2015  
 TIME = 3:52:01 PM

IN CHARGE OF \_\_\_\_\_  
 DESIGNED BY \_\_\_\_\_  
 CHECKED BY \_\_\_\_\_  
 DRAFTED BY \_\_\_\_\_  
 CHECKED BY \_\_\_\_\_

PREPARED BY:  
 ON:

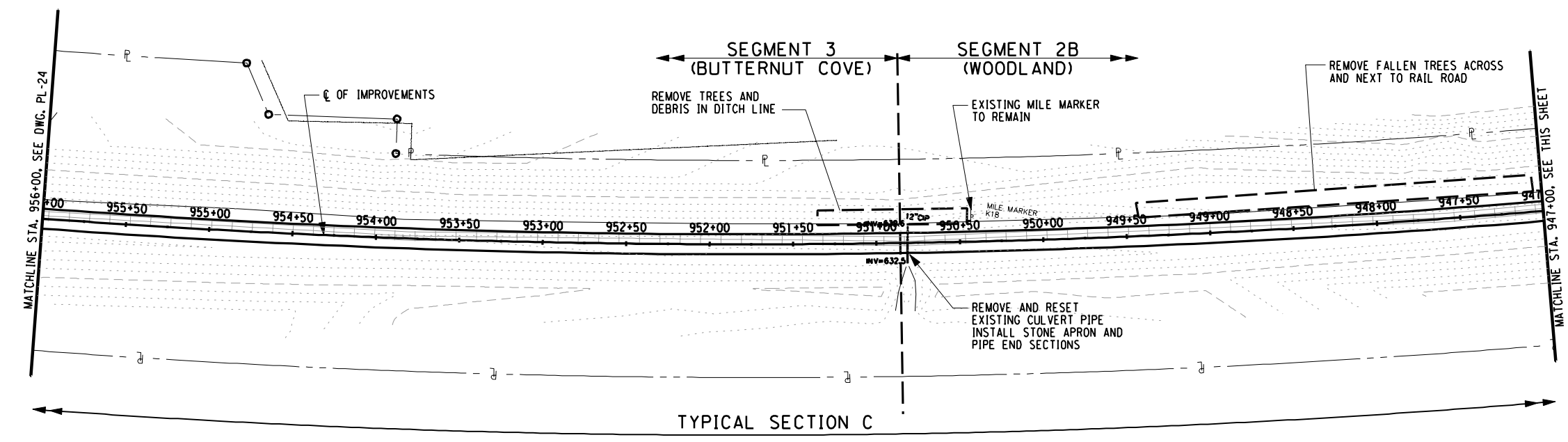
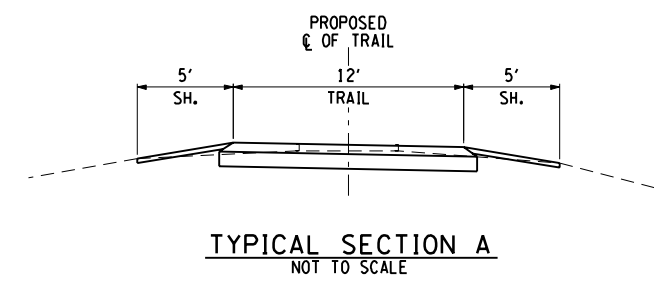
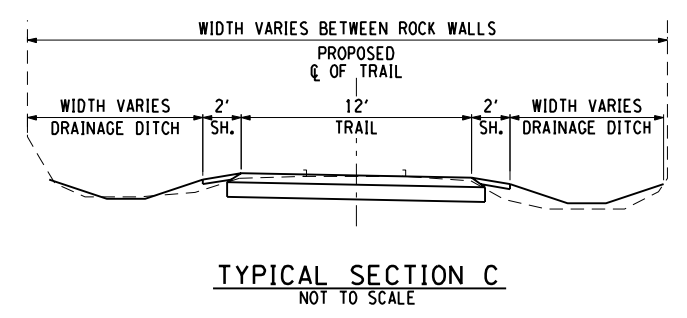
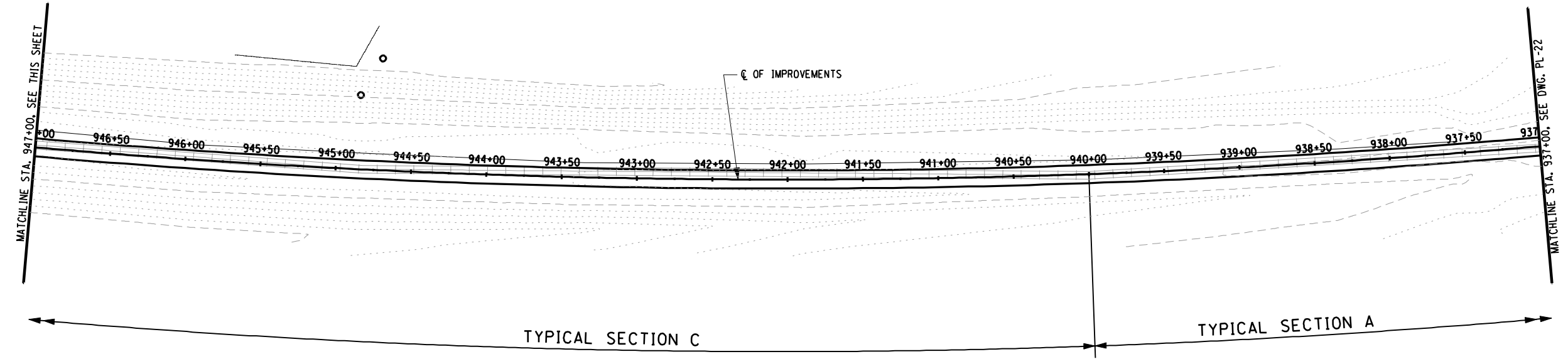

NOTES:  
 1. FOR NOTES AND LEGEND, SEE DWG. PL-1

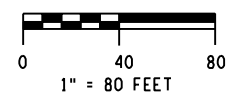

NO.	DATE	BY	REVISION



**Barton & Loguidice, D.P.C.**

UNAUTHORIZED ALTERATION OR ADDITION TO THIS DRAWING IS A VIOLATION OF THE NEW YORK STATE EDUCATION LAW ARTICLE 148 SECTION 7209

CATSKILL MOUNTAIN RAIL TRAIL  
 ASHOKAN SECTION

OPEN SPACE INSTITUTE

ULSTER COUNTY

ALTERNATIVE 1A

GENERAL PLAN 23

SCALE: 1" = 80'

DATE ISSUED: 02/2015

DRAWING PL - 23

XX

L:\MicroStation\Workspace\Pilot\NYSDOT\SITE\NYSDOT\_SIZE\_B.tbl  
 L:\MicroStation\Workspace\Pilot\NYSDOT\NYSDOT.LJ5000.B.04.009.plt

FILE NAME = I:\mstr\_projects\1600\1653\002\001 - cmt phase 2\mstr\design report\1653\002 PL 24.dgn  
 DATE = 2/25/2015  
 TIME = 4:33:40 PM

IN CHARGE OF \_\_\_\_\_ DESIGNED BY \_\_\_\_\_ CHECKED BY \_\_\_\_\_ DRAFTED BY \_\_\_\_\_ CHECKED BY \_\_\_\_\_

PREPARED BY:  
 ON:

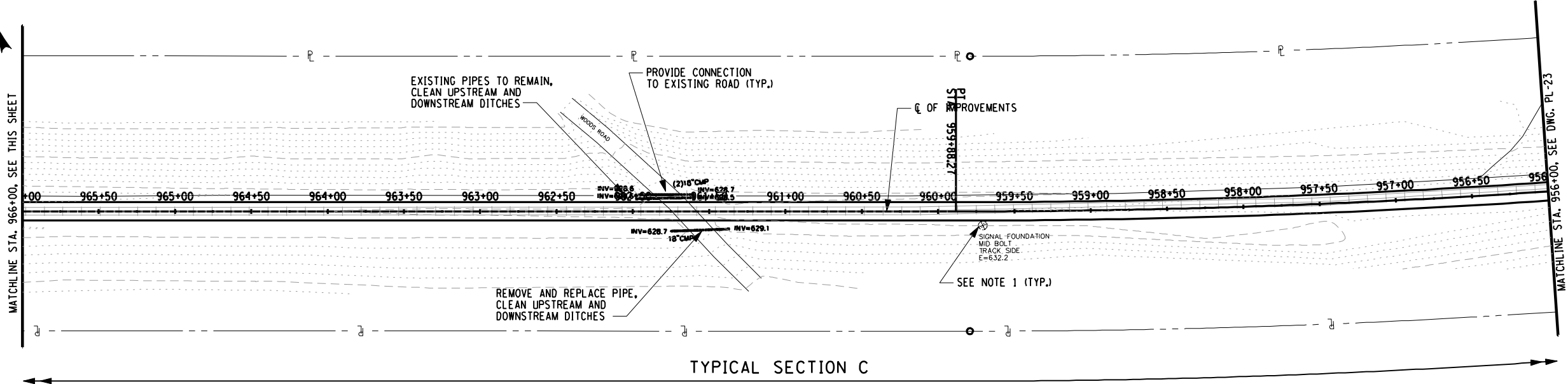
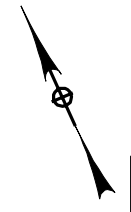

TYPICAL SECTION C

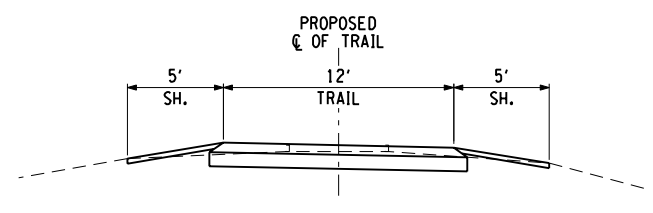

TYPICAL SECTION A  
 NOT TO SCALE

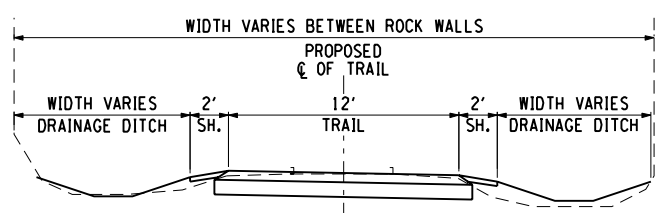

TYPICAL SECTION C  
 NOT TO SCALE

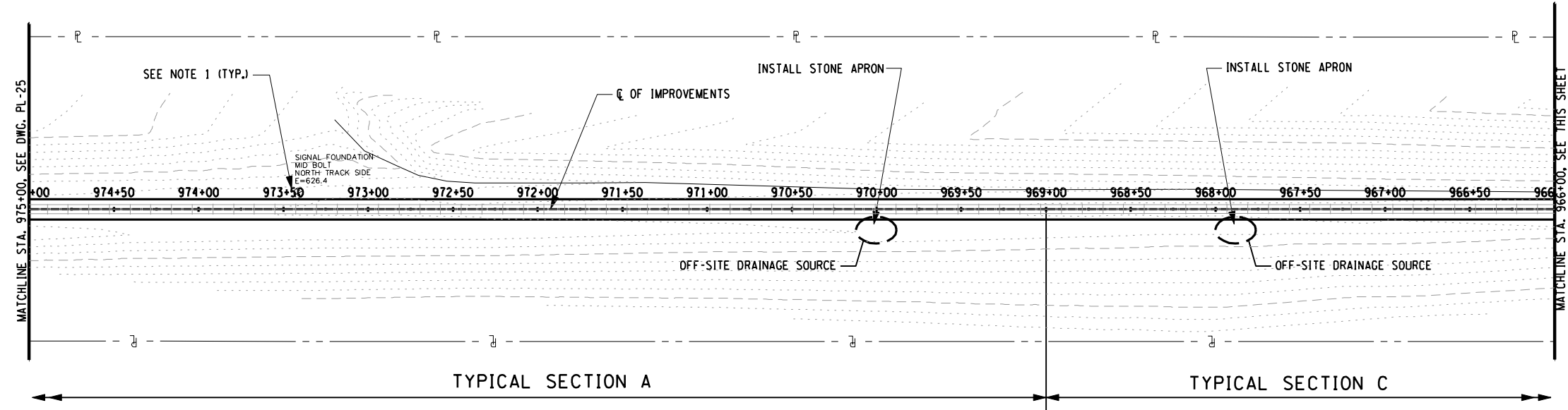
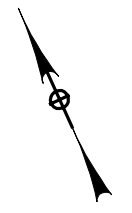

TYPICAL SECTION A

TYPICAL SECTION C

NOTES:  
 1. FOR NOTES AND LEGEND, SEE DWG. PL-1

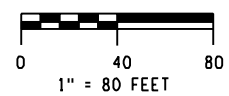

NO.	DATE	BY	REVISION

OPEN SPACE INSTITUTE

**Barton & Loguidice, D.P.C.**

UNAUTHORIZED ALTERATION OR ADDITION TO THIS DRAWING IS A VIOLATION OF THE NEW YORK STATE EDUCATION LAW ARTICLE 148 SECTION 7209

CATSKILL MOUNTAIN RAIL TRAIL ASHOKAN SECTION
OPEN SPACE INSTITUTE
ULSTER COUNTY
ALTERNATIVE 1A

GENERAL PLAN 24
SCALE: 1" = 80
DATE ISSUED: 02/2015
DRAWING PL-24

XX

cmh  
 L:\MicroStation\Workspace\Plot\NYSDOT\SITE\_NYSDOT\_SIZE\_B.tbl  
 L:\MicroStation\Workspace\Plot\NYSDOT\NYSDOT.LJ5000.B.04.009.plt

FILE NAME = I:\mstr\_projects\1600\1653.002.001 - cmrt phase 2\mstr\design report\1653.002 PL 25.dgn  
 DATE = 2/25/2015  
 TIME = 4:33:22 PM

IN CHARGE OF \_\_\_\_\_ DESIGNED BY \_\_\_\_\_ CHECKED BY \_\_\_\_\_ DRAFTED BY \_\_\_\_\_ CHECKED BY \_\_\_\_\_

PREPARED BY:  
 ON:

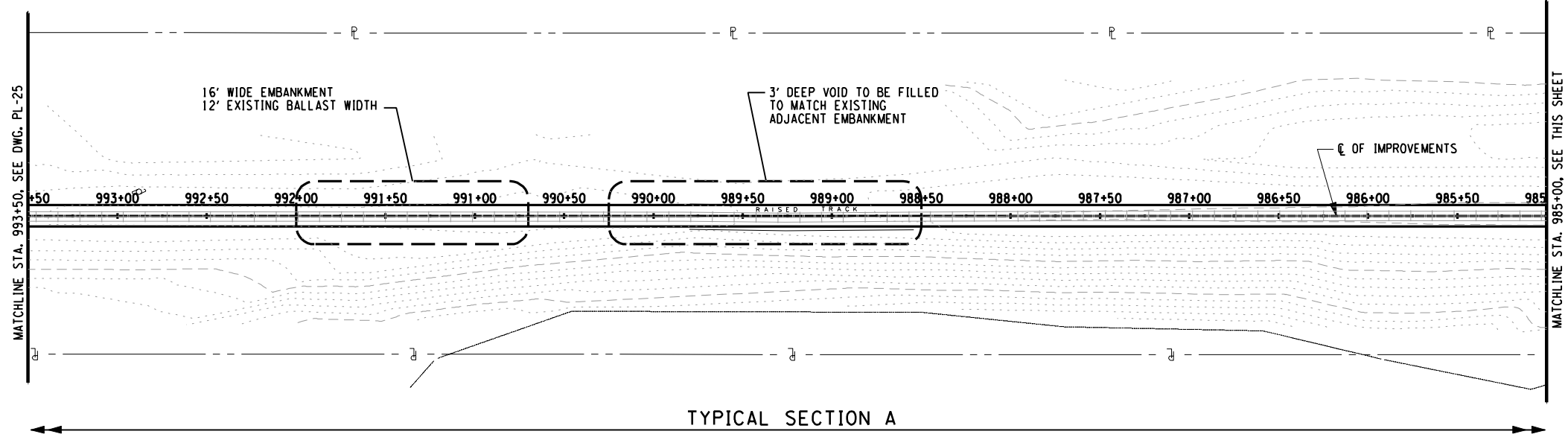
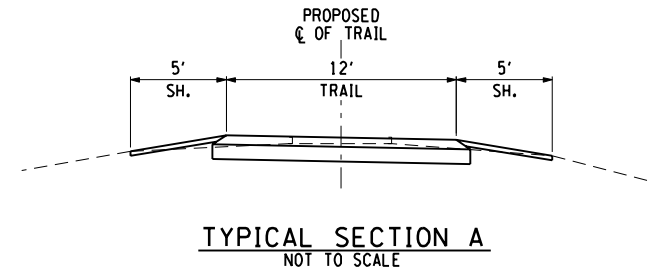
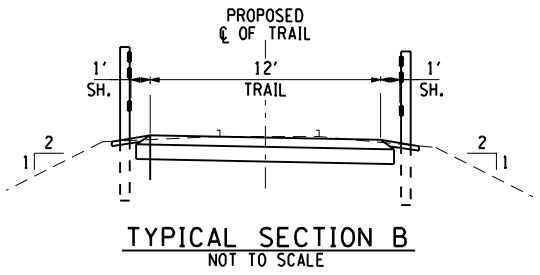
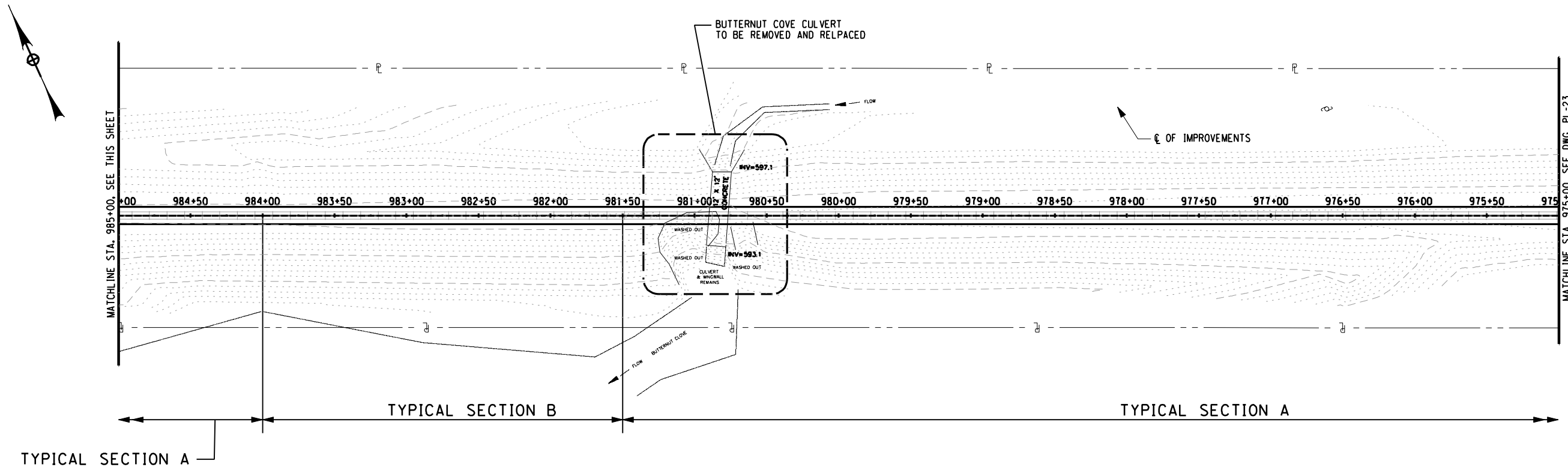

NOTES:  
 1. FOR NOTES AND LEGEND, SEE DWG. PL-1

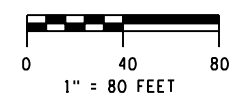

NO.	DATE	BY	REVISION



**Barton & Loguidice, D.P.C.**  
 UNAUTHORIZED ALTERATION OR ADDITION TO THIS DRAWING IS A VIOLATION OF THE NEW YORK STATE EDUCATION LAW ARTICLE 145 SECTION 7209

CATSKILL MOUNTAIN RAIL TRAIL  
 ASHOKAN SECTION  
 OPEN SPACE INSTITUTE  
 ULSTER COUNTY  
 ALTERNATIVE 1A

GENERAL PLAN 25  
 SCALE: 1" = 80'  
 DATE ISSUED: 02/2015  
 DRAWING PL-25

XX

L:\MicroStation\Workspace\Plot\NYSDOT\NYSDOT.L15000.B.04.008.plt

FILE NAME = I:\mstr\_projects\1600\1653.002.001 - cmt phase 2\mstr\design report\1653.002 PL 26.dgn  
 DATE = 2/25/2015  
 TIME = 4:33:26 PM

IN CHARGE OF \_\_\_\_\_ DESIGNED BY \_\_\_\_\_ CHECKED BY \_\_\_\_\_ DRAFTED BY \_\_\_\_\_ CHECKED BY \_\_\_\_\_

PREPARED BY:  
 ON:

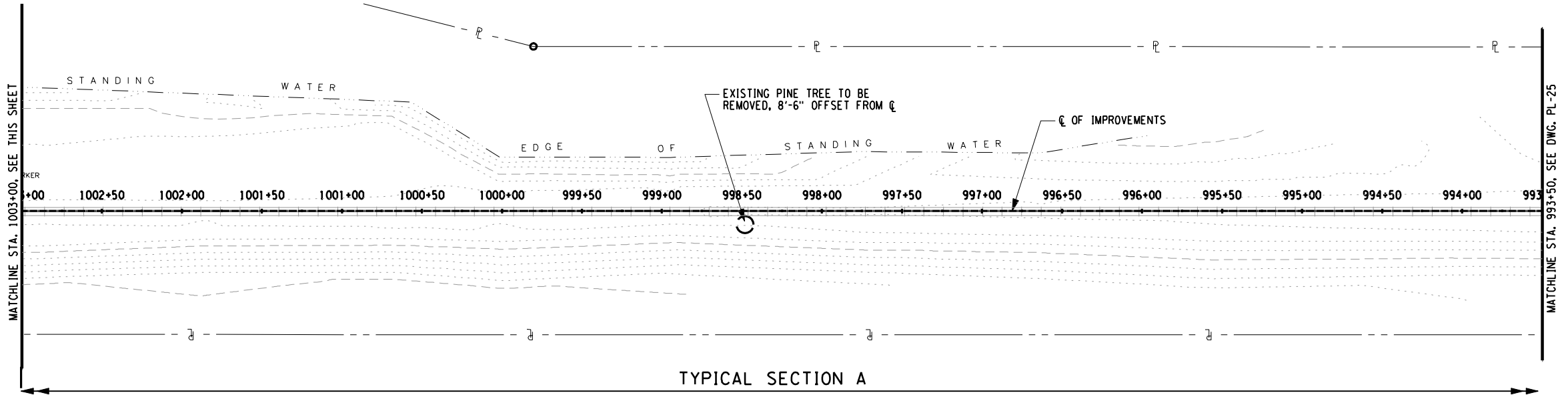

TYPICAL SECTION A

SEGMENT 3  
(BUTTERNUT COVE)

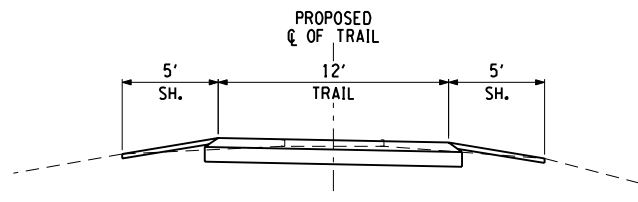

TYPICAL SECTION A  
NOT TO SCALE

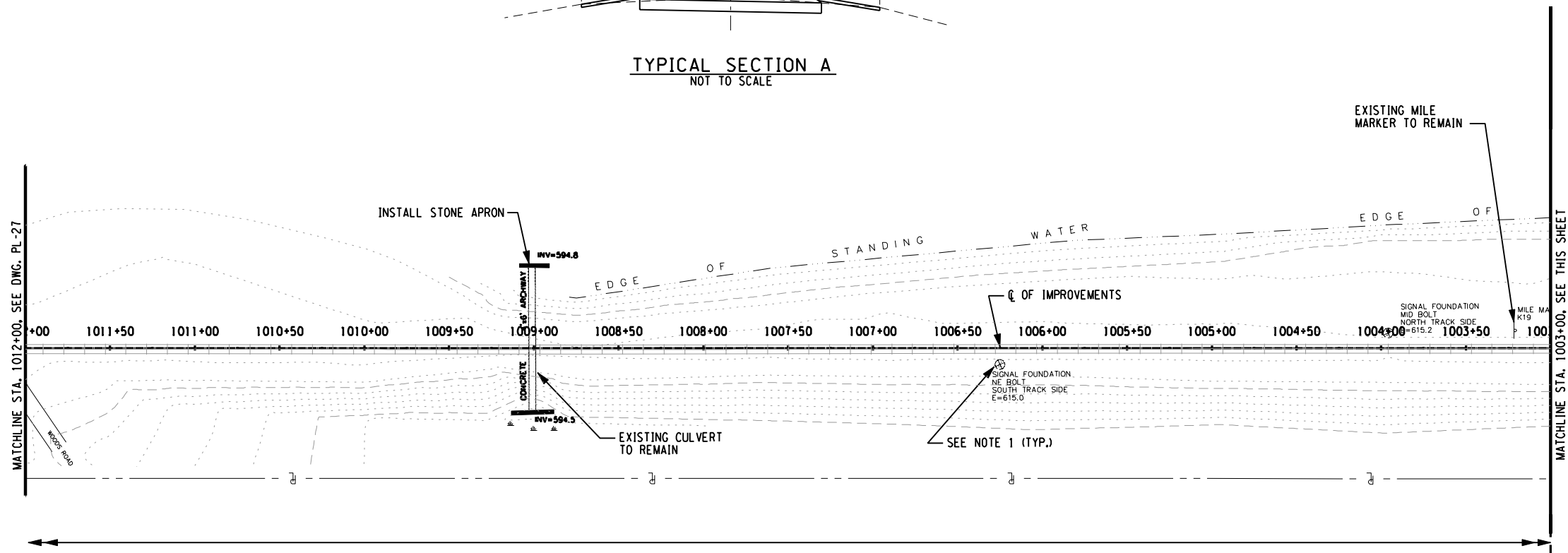

SEGMENT 4  
(ASHOKON)

NOTES:  
 1. FOR NOTES AND LEGEND, SEE DWG. PL-1

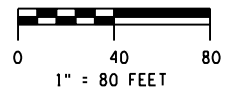

NO. DATE BY REVISION	
<small>UNAUTHORIZED ALTERATION OR ADDITION TO THIS DRAWING IS A VIOLATION OF THE NEW YORK STATE EDUCATION LAW ARTICLE 145 SECTION 7209</small>	
CATSKILL MOUNTAIN RAIL TRAIL ASHOKON SECTION	OPEN SPACE INSTITUTE
ULSTER COUNTY	ALTERNATIVE 1 A
GENERAL PLAN 26	
SCALE: 1" = 80'	
DATE ISSUED: 02/2015	
DRAWING PL-26	

XX

FILE NAME = I:\mstr\_projects\1600\1653\002\001 - cmt phase 2\mstr\design report\1653\002 PL 27.dgn  
 DATE = 2/25/2015  
 TIME = 4:33:28 PM

IN CHARGE OF \_\_\_\_\_ DESIGNED BY \_\_\_\_\_ CHECKED BY \_\_\_\_\_ DRAFTED BY \_\_\_\_\_ CHECKED BY \_\_\_\_\_

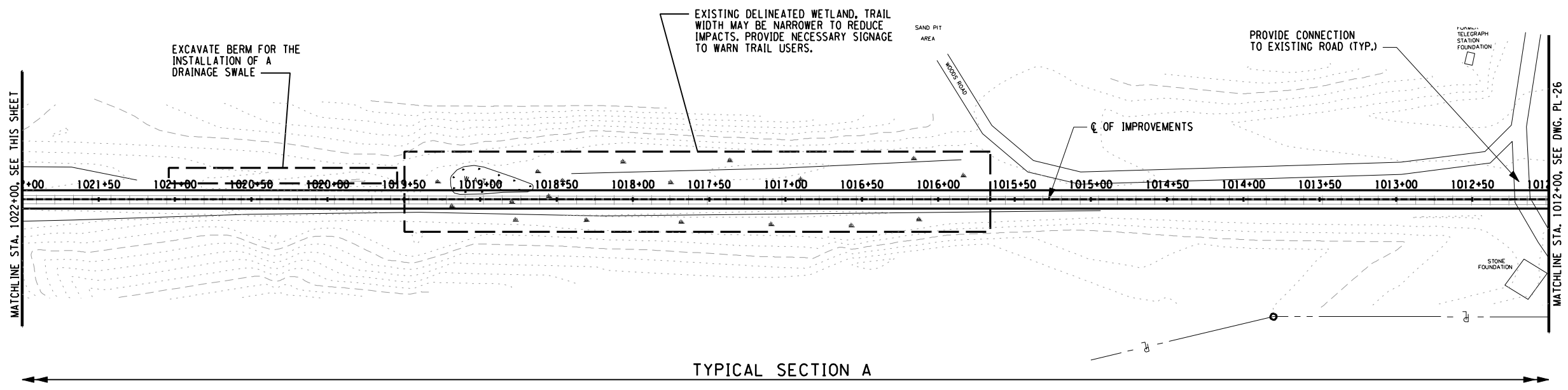

TYPICAL SECTION A

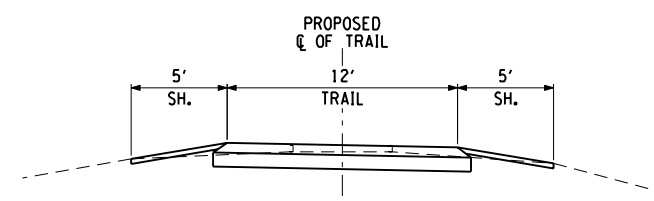

TYPICAL SECTION A  
NOT TO SCALE

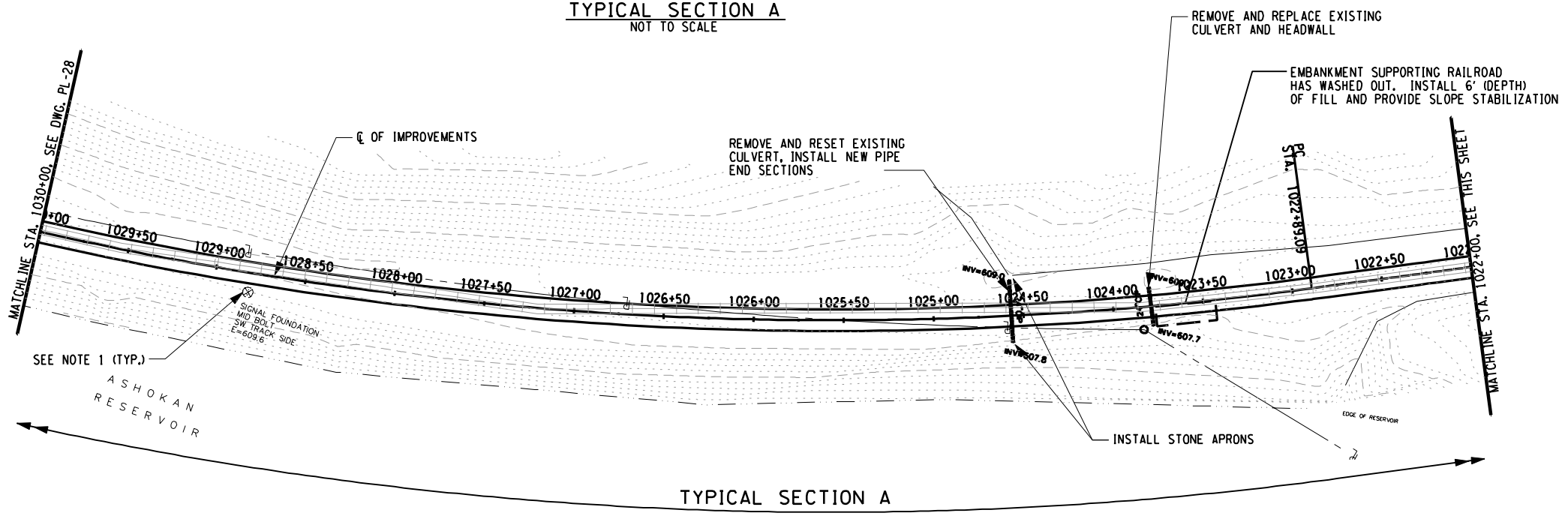

TYPICAL SECTION A

**NOTES:**  
 1. FOR NOTES AND LEGEND, SEE DWG. PL-1

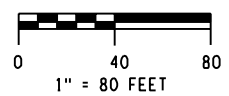

XX			
NO.	DATE	BY	REVISION
<b>Barton</b> <b>&amp; Loguidice, D.P.C.</b>			
CATSKILL MOUNTAIN RAIL TRAIL ASHOKAN SECTION			
OPEN SPACE INSTITUTE		ULSTER COUNTY	
ALTERNATIVE 1 A			
GENERAL PLAN 27			
SCALE: 1" = 80			
DATE ISSUED: 02/2015			
DRAWING PL-27			

UNAUTHORIZED ALTERATION OR ADDITION TO THIS DRAWING IS A VIOLATION OF THE NEW YORK STATE EDUCATION LAW ARTICLE 148 SECTION 7209

L:\MicroStation\Workspace\Plot\NYSDOT\NYSDOT SITE B.tbl  
 L:\MicroStation\Workspace\Plot\NYSDOT\NYSDOT.LJ5000.B.04.009.plt

FILE NAME = I:\mstr\_projects\1600\1653.002.001 - cmt phase 2\mstr\design report\1653.002 PL 28.dgn  
 DATE = 2/25/2015  
 TIME = 4:33:30 PM

IN CHARGE OF \_\_\_\_\_ DESIGNED BY \_\_\_\_\_ CHECKED BY \_\_\_\_\_ DRAFTED BY \_\_\_\_\_ CHECKED BY \_\_\_\_\_

PREPARED BY:  
 ON:

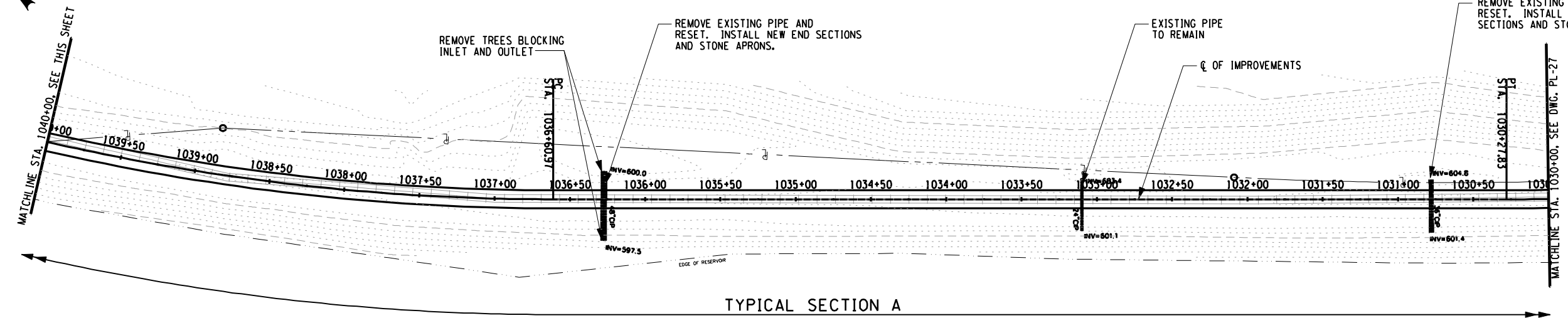
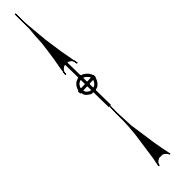

TYPICAL SECTION A

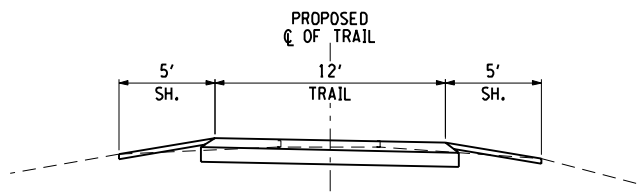

TYPICAL SECTION A  
 NOT TO SCALE

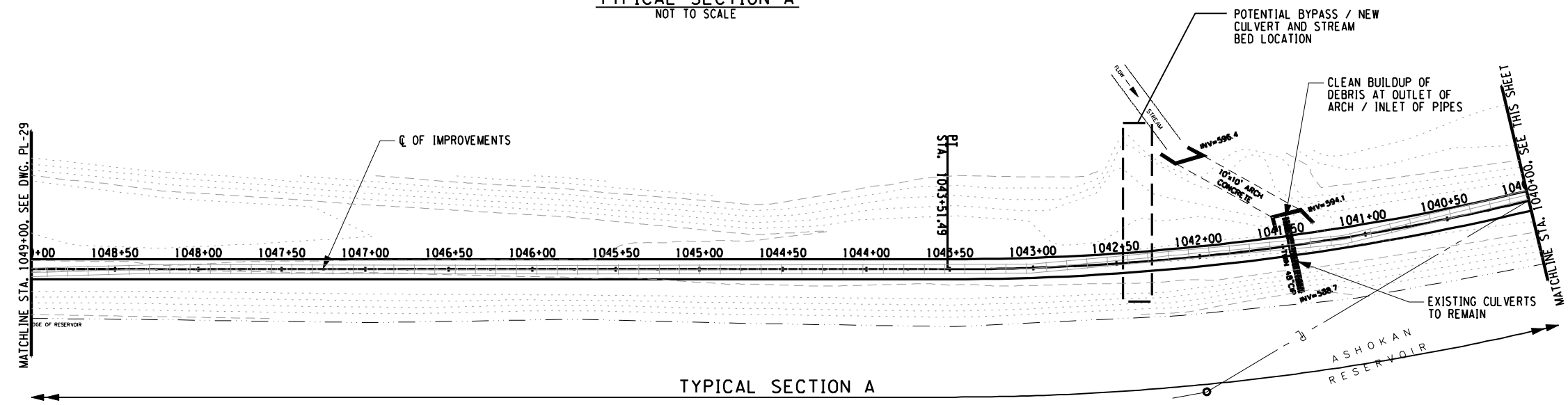

TYPICAL SECTION A

NOTES:  
 1. FOR NOTES AND LEGEND, SEE DWG. PL-1

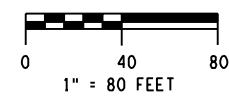

NO.	DATE	BY	REVISION



**Barton**  
**B&E**  
 ognice, D.P.C.

UNAUTHORIZED ALTERATION OR ADDITION TO THIS DRAWING IS A VIOLATION OF THE NEW YORK STATE EDUCATION LAW ARTICLE 145 SECTION 7209

CATSKILL MOUNTAIN RAIL TRAIL  
 ASHOKAN SECTION

OPEN SPACE INSTITUTE

ULSTER COUNTY

ALTERNATIVE 1A

GENERAL PLAN 28

SCALE: 1" = 80'

DATE ISSUED: 02/2015

DRAWING PL - 28

XX



cmh  
 L:\MicroStation\Workspace\Plot\NYSDOT\NYS00T\SIZE\_B.tbl  
 L:\MicroStation\Workspace\Plot\NYSDOT\NYS00T.LJ5000.B.04.00b.plt

FILE NAME = I:\mstr\_projects\1600\1653\002\001 - cmt phase 2\mstr\design report\1653\002 PL 29.dgn  
 DATE = 2/25/2015  
 TIME = 4:33:32 PM

IN CHARGE OF \_\_\_\_\_ DESIGNED BY \_\_\_\_\_ CHECKED BY \_\_\_\_\_ DRAFTED BY \_\_\_\_\_ CHECKED BY \_\_\_\_\_

PREPARED BY:  
 ON:

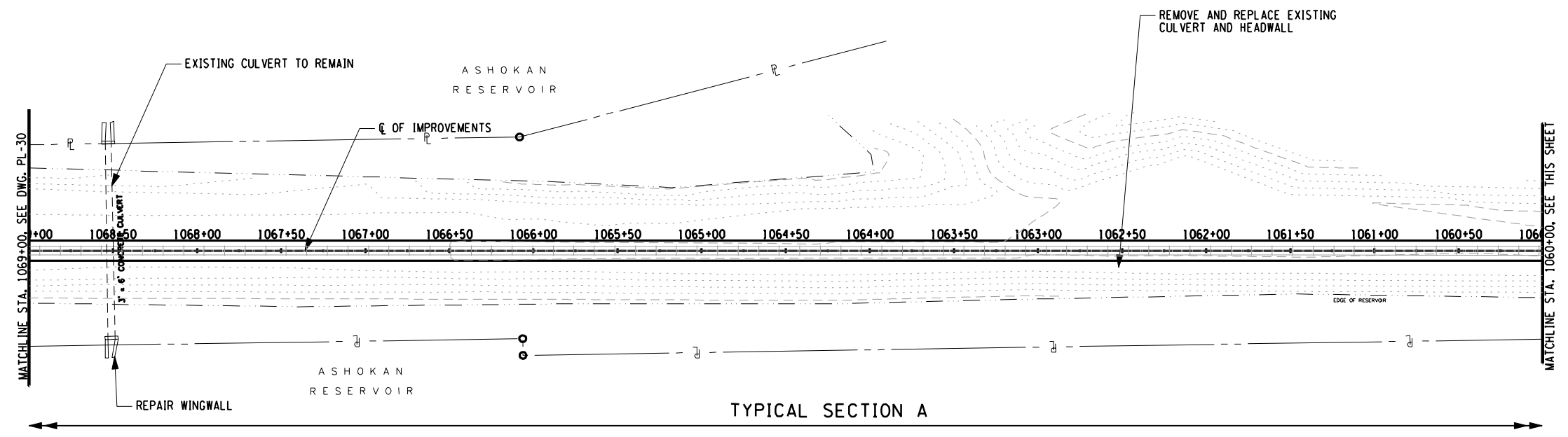
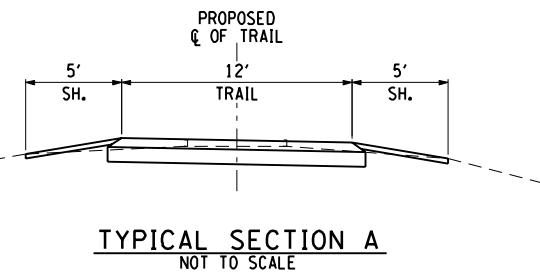
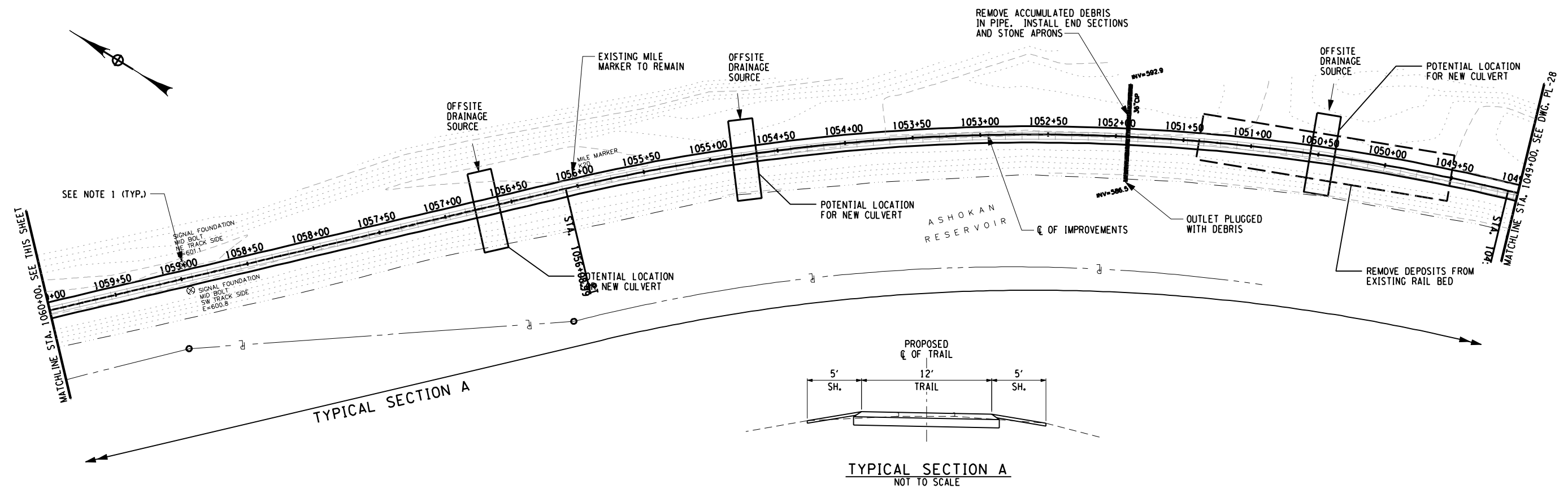

**NOTES:**  
 1. FOR NOTES AND LEGEND, SEE DWG. PL-1

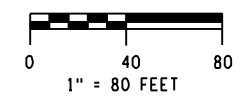

		NO. DATE BY REVISION	
		CATSKILL MOUNTAIN RAIL TRAIL ASHOKAN SECTION	
OPEN SPACE INSTITUTE		Barton <b>B &amp; L</b> oguidice, D.P.C.	
ULSTER COUNTY		UNAUTHORIZED ALTERATION OR ADDITION TO THIS DRAWING IS A VIOLATION OF THE NEW YORK STATE EDUCATION LAW ARTICLE 148 SECTION 7209	
ALTERNATIVE 1A		GENERAL PLAN 29	
SCALE: 1" = 80		DATE ISSUED: 02/2015	
DRAWING PL - 29		XX	

cmh  
 L:\MicroStation\Workspace\Plot\NYSDOT\NYSDOT SITE B.tbl  
 L:\MicroStation\Workspace\Plot\NYSDOT\NYSDOT.LJ5000.B.04.009.plt

FILE NAME = I:\mstr\_projects\1600\1653\002\001 - cmrt phase 2\mstr\design report\1653\002 PL 30.dgn  
 DATE = 2/25/2015  
 TIME = 4:33:34 PM

IN CHARGE OF \_\_\_\_\_ DESIGNED BY \_\_\_\_\_ CHECKED BY \_\_\_\_\_ DRAFTED BY \_\_\_\_\_ CHECKED BY \_\_\_\_\_

PREPARED BY:  
 ON:

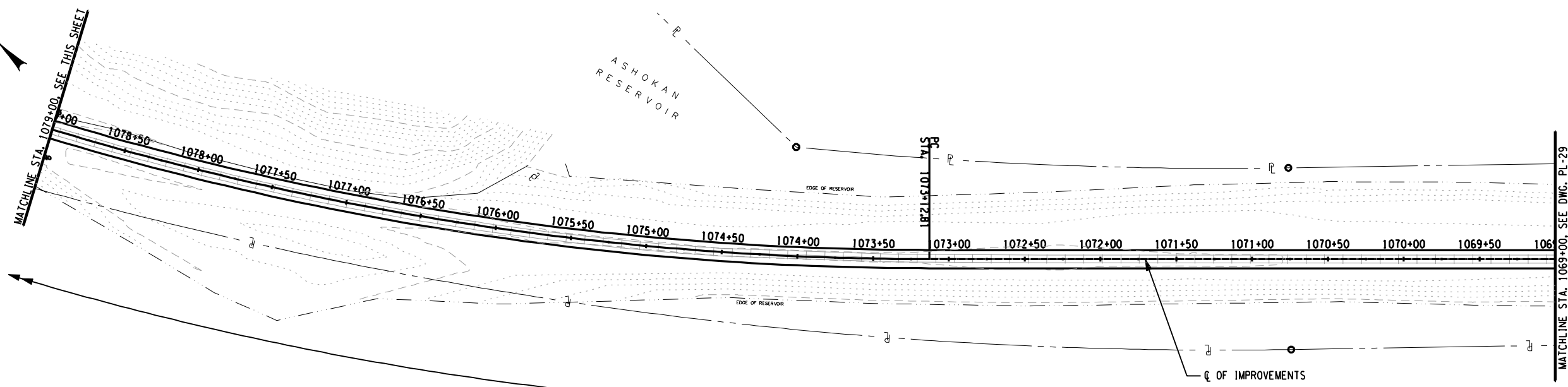
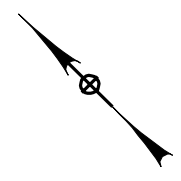

TYPICAL SECTION A

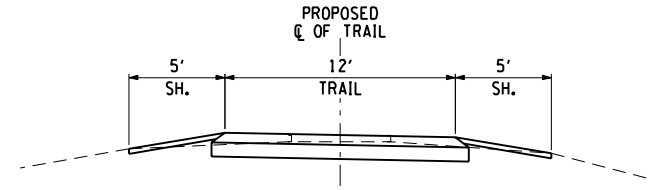

TYPICAL SECTION A  
 NOT TO SCALE

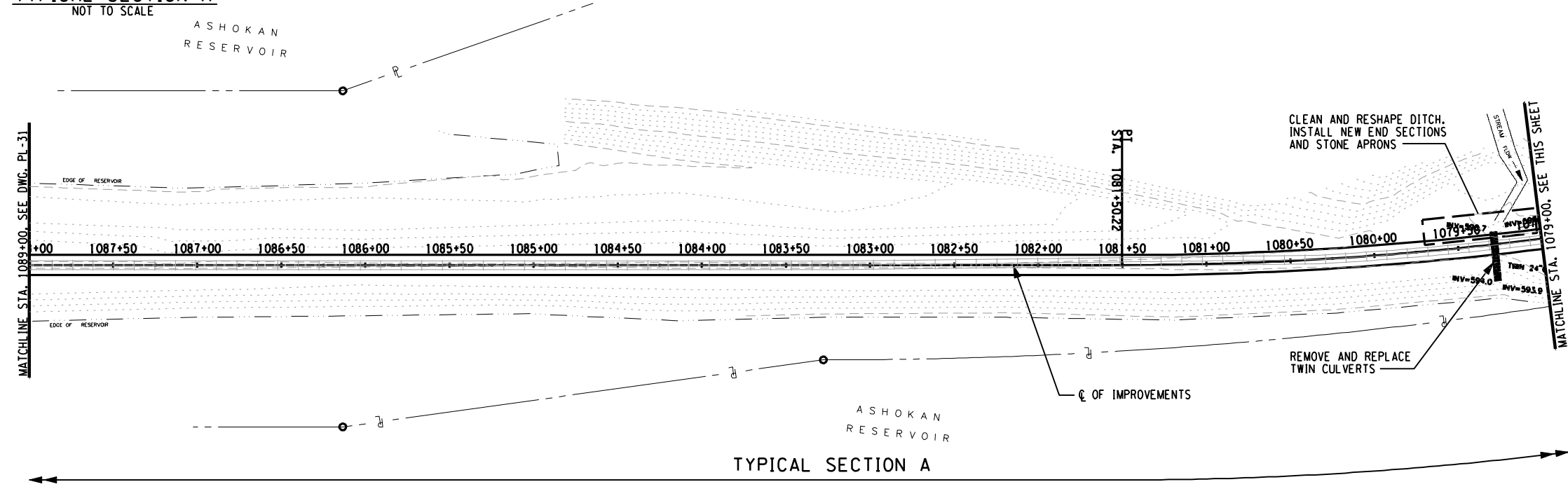

TYPICAL SECTION A

NOTES:  
 1. FOR NOTES AND LEGEND, SEE DWG. PL-1

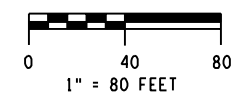

NO.	DATE	BY	REVISION



**Barton**  
**B&E**  
 oguicce, D.P.C.

UNAUTHORIZED ALTERATION OR ADDITION TO THIS DRAWING IS A VIOLATION OF THE NEW YORK STATE EDUCATION LAW ARTICLE 148 SECTION 7208

CATSKILL MOUNTAIN RAIL TRAIL  
 ASHOKAN SECTION

OPEN SPACE INSTITUTE

ULSTER COUNTY

ALTERNATIVE 1A

GENERAL PLAN 30

SCALE: 1" = 80'

DATE ISSUED: 02/2015

DRAWING PL - 30

XX

L:\MicroStation\Workspace\Plot\NYSDOT\NYSDOT.LJ5000.B.04.009.plt

FILE NAME = I:\mstr\_projects\1600\1653.002.001 - cmrt phase 2\mstr\design report\1653.002 PL 31.dgn  
 DATE = 2/25/2015  
 TIME = 4:33:36 PM

IN CHARGE OF \_\_\_\_\_ DESIGNED BY \_\_\_\_\_ CHECKED BY \_\_\_\_\_ DRAFTED BY \_\_\_\_\_ CHECKED BY \_\_\_\_\_

PREPARED BY:  
 ON:



MATCHLINE STA. 1098+00, SEE THIS SHEET



MATCHLINE STA. 1107+00, SEE DWG. PL-32

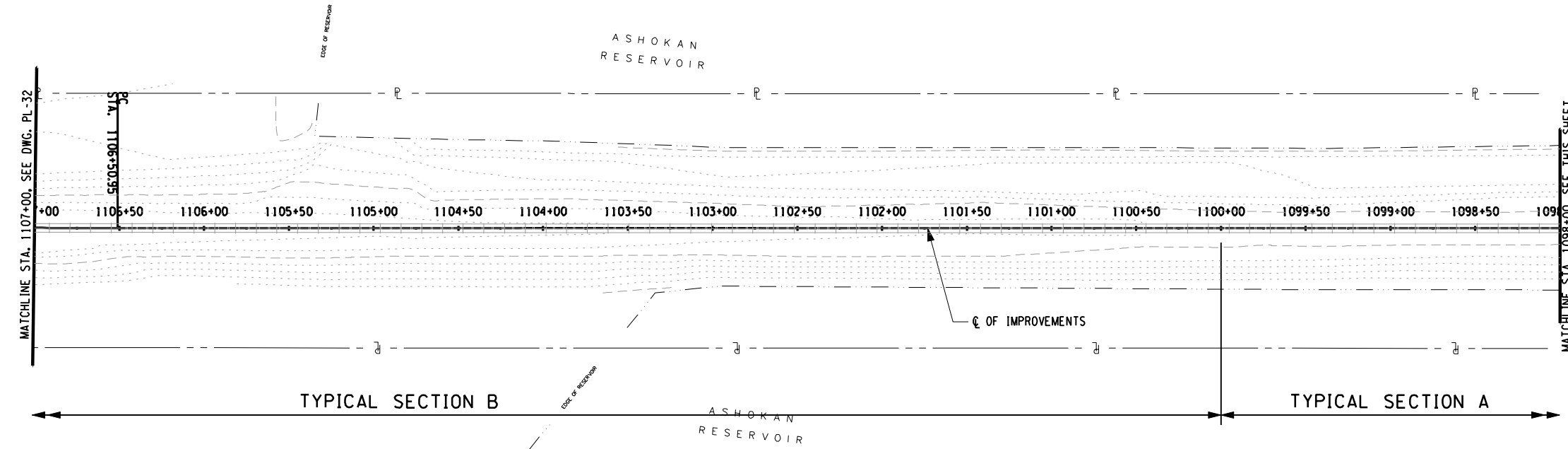
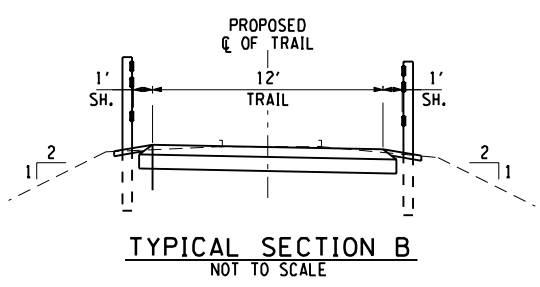
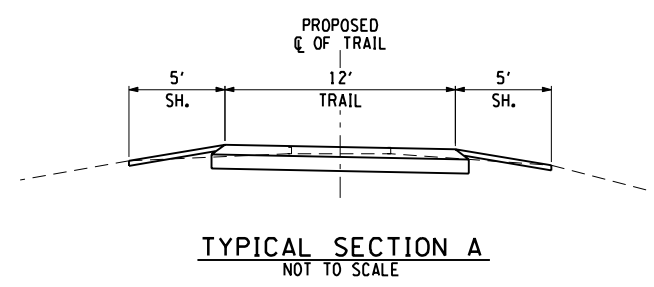
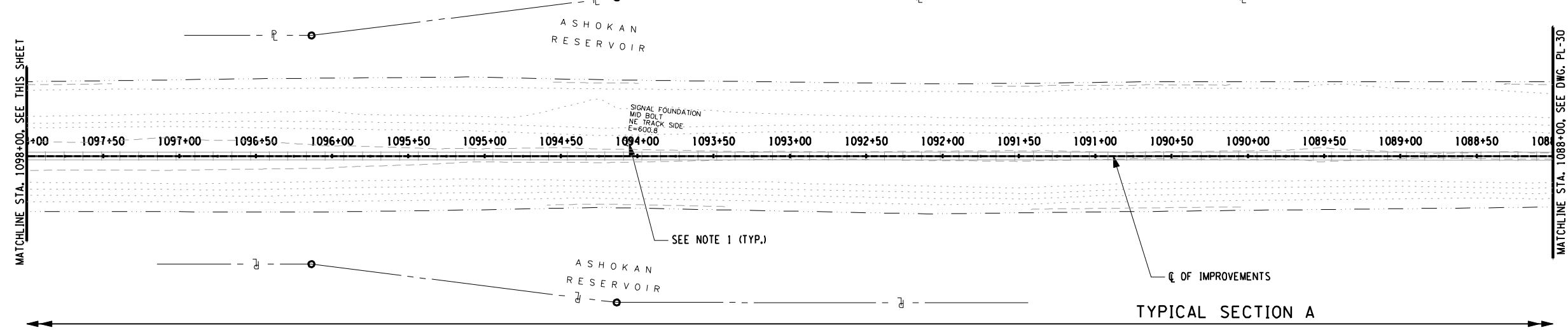

NOTES:  
 1. FOR NOTES AND LEGEND, SEE DWG. PL-1

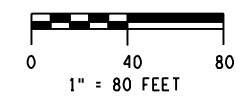

NO. DATE BY REVISION	
<b>Barton</b> <b>B&amp;E</b> oguidice, D.P.C.	
<small>UNAUTHORIZED ALTERATION OR ADDITION TO THIS DRAWING IS A VIOLATION OF THE NEW YORK STATE EDUCATION LAW ARTICLE 145 SECTION 7209</small>	
CATSKILL MOUNTAIN RAIL TRAIL ASHOKAN SECTION	OPEN SPACE INSTITUTE
ULSTER COUNTY	ALTERNATIVE 1A
GENERAL PLAN 31	
SCALE: 1" = 80	
DATE ISSUED: 02/2015	
DRAWING PL - 31	

XX

FILE NAME = I:\mstr\_projects\1600\1653\002\001 - cmt phase 2\mstr\design report\1653\002 PL 32.dgn  
 DATE = 2/25/2015  
 TIME = 4:33:38 PM

IN CHARGE OF \_\_\_\_\_ DESIGNED BY \_\_\_\_\_ CHECKED BY \_\_\_\_\_ DRAFTED BY \_\_\_\_\_ CHECKED BY \_\_\_\_\_

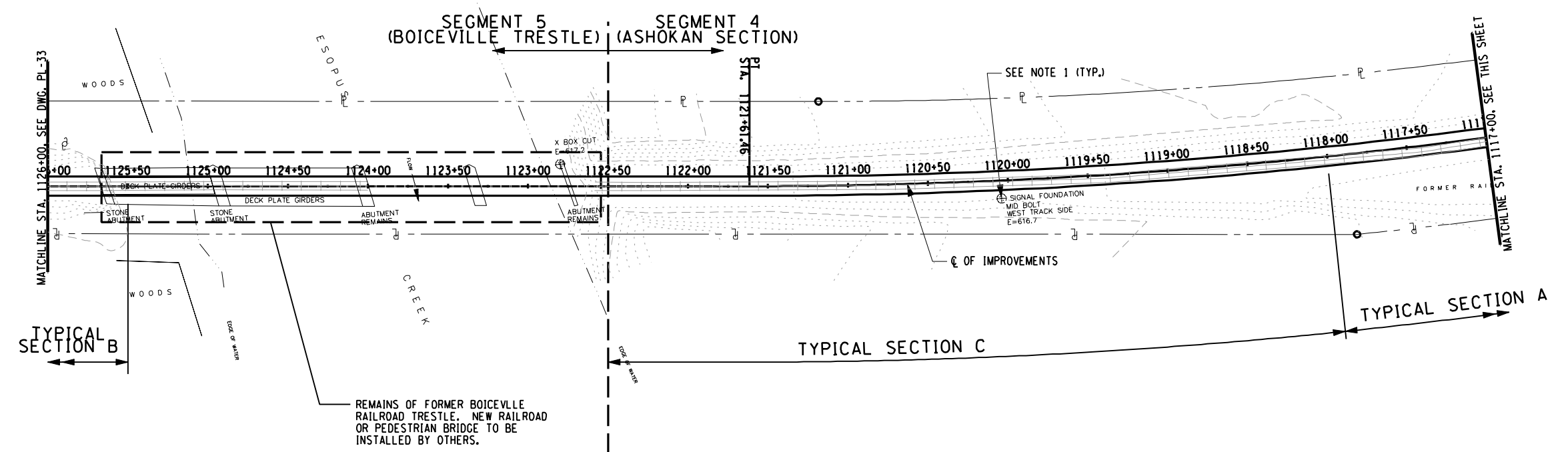
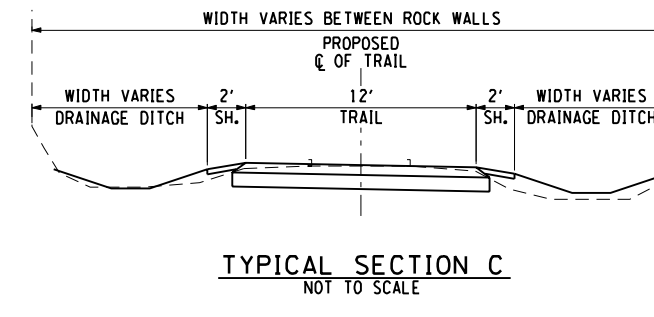
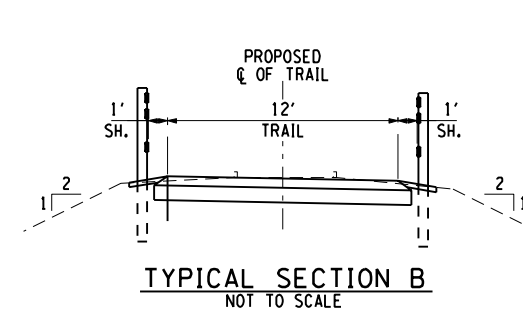
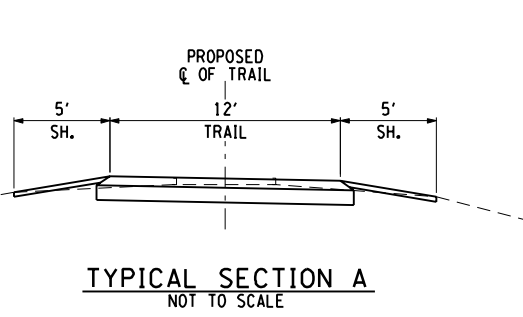
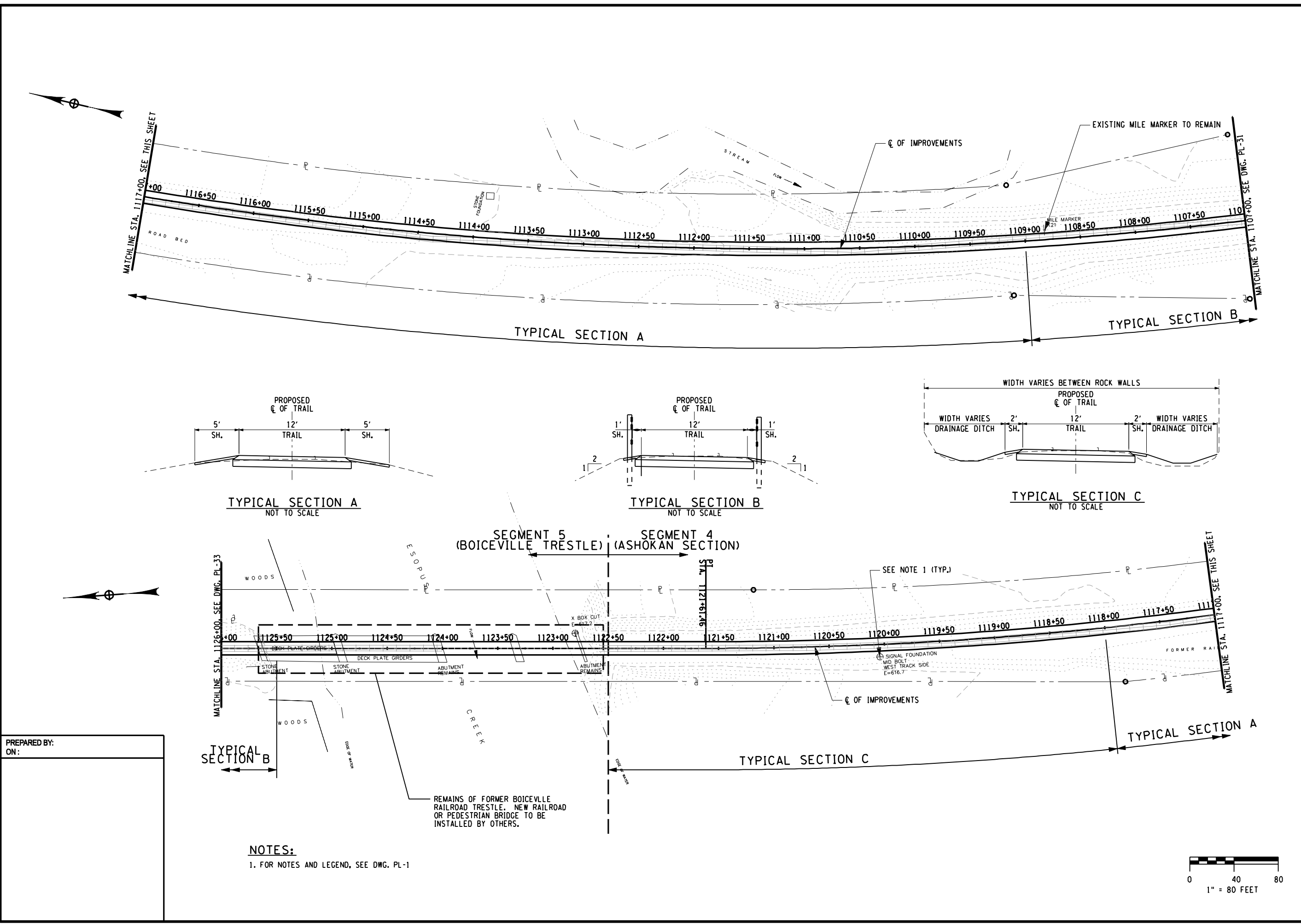

**NOTES:**  
 1. FOR NOTES AND LEGEND, SEE DWG. PL-1

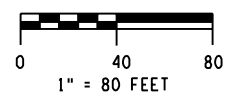

NO. DATE BY REVISION	
 <b>OPEN SPACE INSTITUTE</b>	
 <b>Barton &amp; Loguidice, D.P.C.</b>	
UNAUTHORIZED ALTERATION OR ADDITION TO THIS DRAWING IS A VIOLATION OF THE NEW YORK STATE EDUCATION LAW ARTICLE 145 SECTION 7209	
CATSKILL MOUNTAIN RAIL TRAIL ASHOKAN SECTION	ALTERNATIVE 1 A
OPEN SPACE INSTITUTE	ULSTER COUNTY
<b>GENERAL PLAN 32</b>	
SCALE: 1" = 80'	
DATE ISSUED: 02/2015	
DRAWING PL - 32	

XX

cmh  
 L:\MicroStation\Workspace\Plot\NYSDOT\NYSDOT\_SITE\_B.tbl  
 L:\MicroStation\Workspace\Plot\NYSDOT\NYSDOT.LJ5000.B.04.009.plt

FILE NAME = I:\mstr\_projects\1600\1653\002\001 - cmt phase 2\mstr\design report\1653\002 PL 33.dgn  
 DATE = 2/25/2015  
 TIME = 3:52:15 PM

IN CHARGE OF \_\_\_\_\_ DESIGNED BY \_\_\_\_\_ CHECKED BY \_\_\_\_\_ DRAFTED BY \_\_\_\_\_ CHECKED BY \_\_\_\_\_

PREPARED BY:  
 ON:

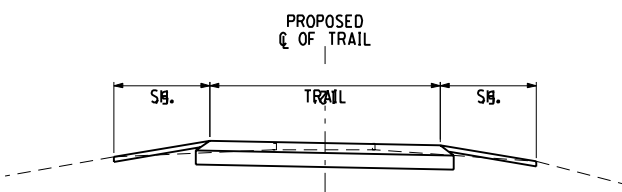
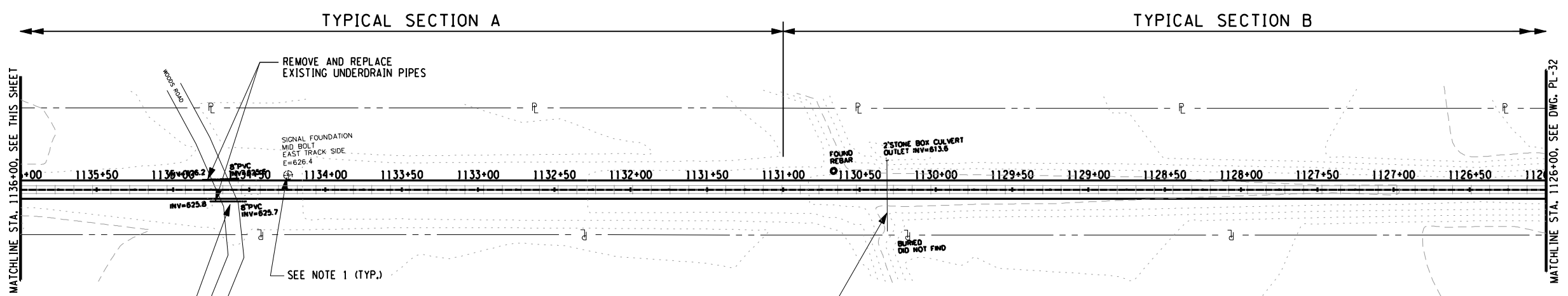
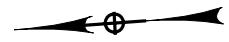
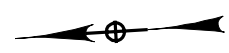

TYPICAL SECTION A  
 NOT TO SCALE

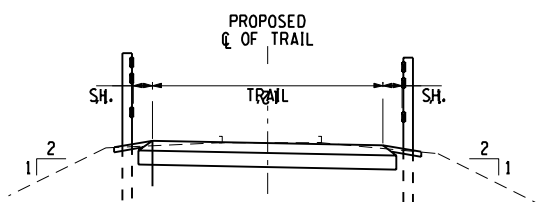

TYPICAL SECTION B  
 NOT TO SCALE

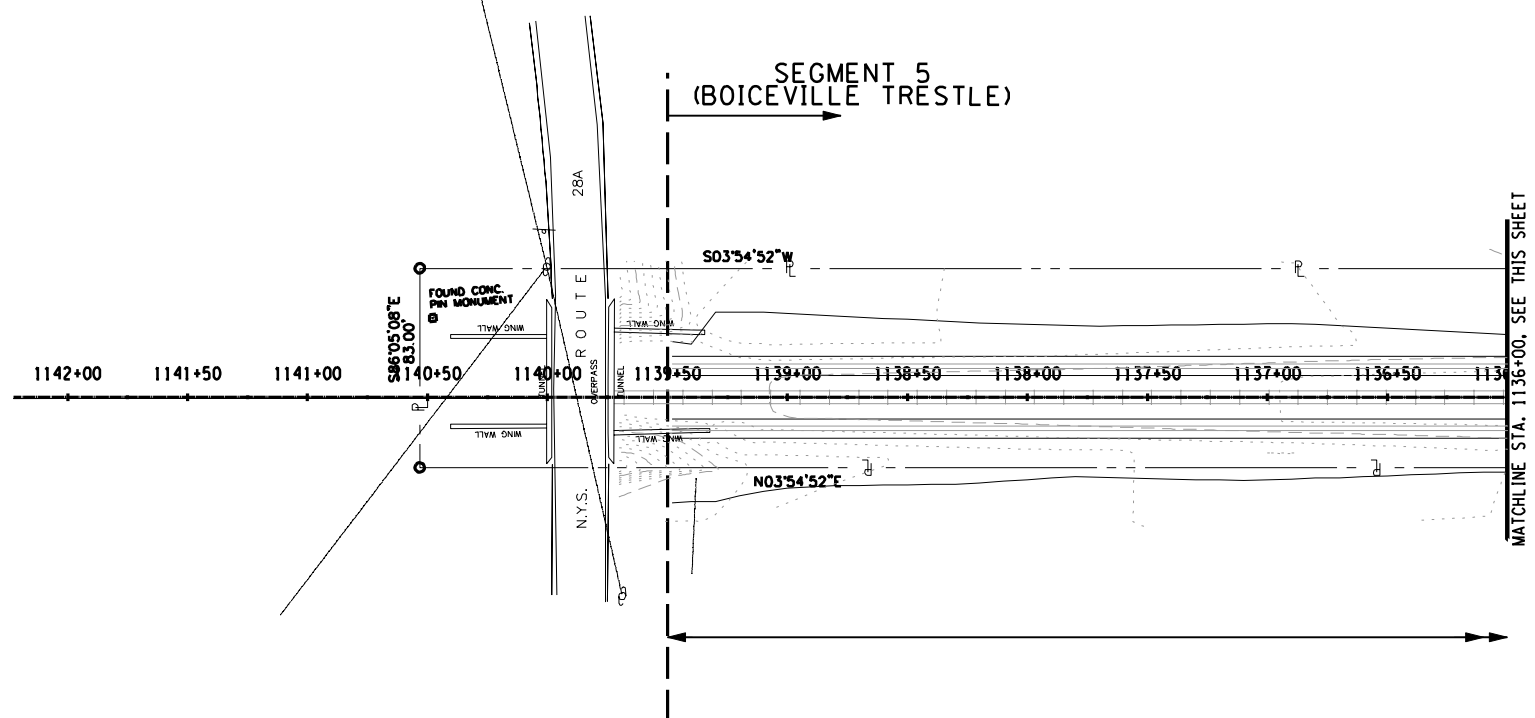

NOTES:  
 1. FOR NOTES AND LEGEND, SEE DWG. PL-1

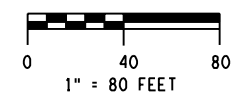

	NO. DATE BY REVISION
	UNAUTHORIZED ALTERATION OR ADDITION TO THIS DRAWING IS A VIOLATION OF THE NEW YORK STATE EDUCATION LAW ARTICLE 145 SECTION 7209
CATSKILL MOUNTAIN RAIL TRAIL ASHOKAN SECTION	OPEN SPACE INSTITUTE ULSTER COUNTY ALTERNATIVE 1 A
GENERAL PLAN 33	SCALE: 1" = 80' DATE ISSUED: 02/2015 DRAWING PL - 33

XX

## **Appendix B**

### **Photo Log**

## Rock wall Segment (Segment 1) Photos



Milepost K10 – Milepost K14



**Photo 101** – Manual Track Switch



**Photo 102** –Existing Rail System Conditions





**Photo 103** – minor pine tree growth on rail bed and embankment



**Photo 104** – Vegetation growth at the top of the Glenford Dike



**Photo 105** – Typical fill section



**Photo 106** – Rock cut section/fallen trees



**Photo 107** – Generally flat section



**Photo 108** – Rock slide (station rr 550+00)



**Photo 109** – Damaged culvert headwall



**Photo 110** – Acceptable culvert headwall condition



**Photo 111** – Damaged culvert



**Photo 112** – Acceptable culvert condition, minor scour on bottom slab



**Photo 113** – Drainage Ditch requiring tree/debris removal



**Photo 114** – Possible parking and trail access location



**Photo 115** – View from top of West Hurley Dike



**Photo 116** – Rock Wall



**Photo 117** – Narrow fill section



**Photo 118** – Steep Fill Slope





**Photo 119** – Rock cut section



**Photo 120** – Fill section requiring tree removal.



**Photo 121** – section requiring debris removal



**Photo 122** – Rock Slide (station 482+00)



**Photo 123** – Large culvert requiring wingwall repair



**Photo 124** – large culvert requiring minor wingwall repair



**Photo 125** – Manmade rock wall

## Woodland Segment (Segment 2) Photos



Milepost K14 – Milepost K18



**Photo 201** – fill slopes both sides of tracks



**Photo 202** – Fill and earth cut section w/ drainage ditch



**Photo 203** – Earth cut section with drainage ditches



**Photo 204** – Generally flat section



**Photo 205** – Old concrete signal foundation



**Photo 206** – Old Catskill Mountain Rail Road Caboose





**Photo 207** – Track maintenance equipment



**Photo 208** – Significant tree debris adjacent to tracks



**Photo 209** – Drainage ditch with significant debris accumulation



**Photo 210** – Pine tree growth on rail bed and embankment



**Photo 211** – Minor ballast erosion



**Photo 212** – Steel drainage pipe



**Photo 213** – Steel pipe headwall



**Photo 214** – Large concrete arch culvert good condition



**Photo 215** – Potential trail access and parking location



**Photo 216** – Reservoir road underpass



**Photo 217** – Stone walls through the woods

## Butternut Cove (Segment 3) Photos



Milepost K18 – Milepost K19



**Photo 301** – General rail infrastructure conditions



**Photo 302** – General vegetation characteristics





**Photo 303** – Earth cut slopes with drainage ditches



**Photo 304** – Fill Slopes and wide top embankment



**Photo 305** – Fill slopes and narrow top embankment



**Photo 306** – Steep side slopes



**Photo 307** – Side slope erosion



**Photo 308** – Butternut Creek embankment washout



**Photo 309** – Butternut Creek embankment washout

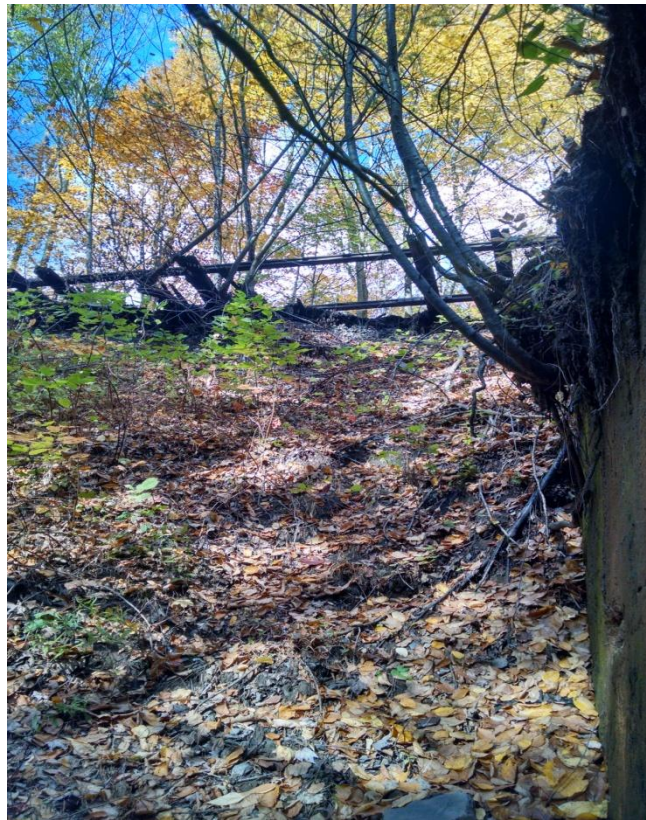

**Photo 310** – Butternut Creek embankment washout



**Photo 311** – Upstream side of Butternut Creek culvert



**Photo 312** – Downstream side of Butternut Creek culvert



**Photo 313** – Raised tracks/ballast washout

## **Ashokan Shore (Segment 4) Photos**



**Milepost K19 – Milepost K21¼**



**Photo 401** – Steel rails and wooden ties in good condition



**Photo 402** – Split and deteriorated wooden ties





**Photo 403** – Tracks completely covered by earth



**Photo 404** – Minor tree growth on rail bed and embankments



**Photo 405** – Heavy brush growth on rail bed and embankments



**Photo 406** – Dense brush and fallen trees on tracks and side slopes



**Photo 407** – Fallen trees on sideslopes



**Photo 408** – Ashokan Reservoir and Rail



**Photo 409** – Railroad corridor built into the hillside



**Photo 410** – Steep hillside on the right side of the tracks



**Photo 411** – “Causeway” section through the Ashokan Reservoir



**Photo 412** – Earth cut slopes on both sides of the tracks



**Photo 413** – Erosion of ballast and embankment



**Photo 414** – Concrete drainage culvert in good condition



**Photo 415** – Complete separation of a section of drainage pipe



**Photo 416** – Settlement/sag of steel culvert



**Photo 417** – 48” diameter steel culvert showing greater than 75% blockage



**Photo 418** – Two 48” diameter steel culverts nearly 100% blocked with debris





**Photo 419** – Concrete culvert approximately 50% or greater filled with sediment



**Photo 420** – Erosion of hillside draining down into blocked culverts



**Photo 421** – Stone and sediment blockage at outlet of steel culvert



**Photo 422** – Erosion and sediment deposition on the Ashokan Reservoir shore



**Photo 423** – Erosion of stone ballast and embankment below tracks



**Photo 424** – Separation of three different culvert sections



**Photo 425** – Erosion of hillside draining into Ashokan Reservoir



**Photo 426** – View from the tracks of Ashokan Reservoir through the trees



**Photo 427** – Panoramic view of the Ashokan Reservoir taken from the shore line

## **Boiceville Trestle (Segment 5) Photos**



**Milepost K21<sup>1</sup>/<sub>4</sub> – Milepost K21<sup>1</sup>/<sub>2</sub>**



**Photo 501** – Bent steel rails caused by the washout



**Photo 502** – Former location of the trestle



**Photo 503** – Trestle section resting on stream bed



**Photo 504** – Remaining Trestle section





**Photo 505** – Section of trestle washed up on shore



**Photo 506** – Fill slopes on both sides of the tracks



**Photo 507** – Drainage ditches and cut slopes



**Photo 508** – Non-functional stone drainage structure

## **Appendix C**

### **Estimate**

**Option 1A  
Construction Project Costs**

Activities	Segment 1	Segment 2A	Segment 2B	Segment 3	Segment 4	Segment 5	Total
Surface	-	-	-	-	-	-	See Below
Subbase (4" thickness)	\$152,341	\$86,804	\$65,573	\$37,697	\$86,299	\$9,930	<b>\$438,644</b>
Wooden Pedestrian Safety Rail	\$415,000	\$220,000	\$104,000	\$20,000	\$72,000	\$42,000	<b>\$873,000</b>
Turf Establishment	\$32,354	\$20,911	\$13,244	\$8,840	\$24,889	\$2,356	<b>\$102,594</b>
Fine Grading	\$159,494	\$95,336	\$67,424	\$40,968	\$102,160	\$10,840	<b>\$476,222</b>
Excavation	-	-	-	-	-	-	<b>\$0</b>
RR (Tracks and Tie) Removal	-	-	-	-	-	-	<b>\$0</b>
<b>Trail Construction and Material) Costs</b>	<b>\$759,190</b>	<b>\$423,052</b>	<b>\$250,241</b>	<b>\$107,505</b>	<b>\$285,348</b>	<b>\$65,125</b>	<b>\$1,890,460</b>
Clearing	\$24,000	\$15,000	\$2,000	\$2,000	\$69,000	\$1,000	<b>\$113,000</b>
Drainage (case-by-case eval.)	\$240,000	\$92,000	\$42,000	\$17,000	\$155,000	\$12,000	<b>\$558,000</b>
Trail Access Facility	-	-	-	-	-	-	<b>\$0</b>
Trail Access Adjustment (+/-10-15%)	\$75,919	\$42,305	\$25,024	\$10,751	\$42,802	\$6,513	<b>\$203,313</b>
<b>Total Construction Cost</b>	<b>\$1,099,108</b>	<b>\$572,357</b>	<b>\$319,265</b>	<b>\$137,256</b>	<b>\$552,150</b>	<b>\$84,638</b>	<b>\$2,764,774</b>
Survey (+/- 2%)	\$21,982	\$11,447	\$6,385	\$2,745	\$11,043	\$1,693	<b>\$55,295</b>
Contingency (+/- 15%)	\$164,866	\$85,854	\$47,890	\$20,588	\$82,822	\$12,696	<b>\$414,716</b>
Field Change Payment (5%)	\$54,955	\$28,618	\$15,963	\$6,863	\$27,607	\$4,232	<b>\$138,239</b>
Mobilization (5%)	\$54,955	\$28,618	\$15,963	\$6,863	\$27,607	\$4,232	<b>\$138,239</b>
<b>Subtotal (2015 Dollars)</b>	<b>\$1,395,868</b>	<b>\$726,893</b>	<b>\$405,467</b>	<b>\$174,315</b>	<b>\$701,230</b>	<b>\$107,490</b>	<b>\$3,511,263</b>
Construction Inspection (10%)	\$140,000	\$73,000	\$41,000	\$18,000	\$71,000	\$11,000	<b>\$354,000</b>
<b>Total Project Costs per Segment</b>	<b>\$1,540,000</b>	<b>\$800,000</b>	<b>\$450,000</b>	<b>\$200,000</b>	<b>\$780,000</b>	<b>\$120,000</b>	<b>\$3,890,000</b>

Surface Treatment Options:	Additional Cost	Total Project Cost
Stone Dust	\$267,867	<b>\$4,200,000</b>
Porous Asphalt	\$3,363,497	<b>\$7,300,000</b>
1" Subbase	\$93,246	<b>\$4,000,000</b>
2" Dirt/Soil Surface	\$918,400	<b>\$4,900,000</b>
Road Oyl©	\$1,383,340	<b>\$5,300,000</b>

**Option 1B  
Construction Project Costs**

Activities	Segment 1	Segment 2A	Segment 2B	Segment 3	Segment 4	Segment 5	Total
Surface	-	-	-	-	-	-	See Below
Subbase (4" thickness)	\$152,341	\$86,804	\$65,573	\$37,697	\$86,299	-	\$428,714
Wooden Pedestrian Safety Rail	\$128,000	\$68,000	\$80,000	\$0	\$9,930	\$0	\$285,930
Turf Establishment	\$36,771	\$22,884	\$13,671	\$9,173	\$25,956	\$3,056	\$111,511
Fine Grading	\$57,752	\$25,848	\$31,232	\$11,648	\$2,880	\$0	\$129,360
Excavation	\$329,630	\$219,489	\$111,067	\$89,911	\$304,111	\$36,361	\$1,090,569
RR (Tracks and Tie) Removal	-	-	-	-	-	-	\$0
<b>Trail Construction and Material) Costs</b>	<b>\$704,494</b>	<b>\$423,026</b>	<b>\$301,543</b>	<b>\$148,430</b>	<b>\$429,175</b>	<b>\$39,417</b>	<b>\$2,046,084</b>
Clearing	\$31,000	\$15,000	\$2,000	\$3,100	\$69,000	\$1,000	\$121,100
Drainage (case-by-case eval.)	\$240,000	\$92,000	\$42,000	\$17,000	\$155,000	\$12,000	\$558,000
Trail Access Facility	-	-	-	-	-	-	\$0
Trail Access Adjustment (+/-10-15%)	\$70,449	\$42,303	\$30,154	\$14,843	\$64,376	\$3,942	\$226,067
<b>Total Construction Cost</b>	<b>\$1,045,944</b>	<b>\$572,328</b>	<b>\$375,697</b>	<b>\$183,372</b>	<b>\$717,552</b>	<b>\$56,358</b>	<b>\$2,951,251</b>
Survey (+/- 2%)	\$20,919	\$11,447	\$7,514	\$3,667	\$14,351	\$1,127	\$59,025
Contingency (+/- 15%)	\$156,892	\$85,849	\$56,355	\$27,506	\$107,633	\$8,454	\$442,688
Field Change Payment (5%)	\$52,297	\$28,616	\$18,785	\$9,169	\$35,878	\$2,818	\$147,563
Mobilization (5%)	\$52,297	\$28,616	\$18,785	\$9,169	\$35,878	\$2,818	\$147,563
<b>Subtotal (2015 Dollars)</b>	<b>\$1,328,348</b>	<b>\$726,857</b>	<b>\$477,135</b>	<b>\$232,883</b>	<b>\$911,291</b>	<b>\$71,575</b>	<b>\$3,748,089</b>
Construction Inspection (10%)	\$133,000	\$73,000	\$48,000	\$24,000	\$92,000	\$8,000	\$378,000
<b>Total Project Costs per Segment</b>	<b>\$1,470,000</b>	<b>\$800,000</b>	<b>\$530,000</b>	<b>\$260,000</b>	<b>\$1,010,000</b>	<b>\$80,000</b>	<b>\$4,150,000</b>

Surface Treatment Options:	Additional Cost	Total Project Cost
Stone Dust	\$267,867	\$4,500,000
Porous Asphalt	\$3,363,497	\$7,600,000
1" Subbase	\$93,246	\$4,300,000
2" Dirt/Soil Surface	\$918,400	\$5,100,000
Road Oyl©	\$1,383,340	\$5,600,000

## **Appendix D**

### **Boiceville Trestle Assessment**

# Alternative Assessment and Option Report

Boiceville Trestle  
Catskill Mountain Railroad Bridge over Esopus Creek (MP 21.3)

Town of Olive  
Ulster County, New York

October 2014



Prepared by Barton & Loguidice, D.P.C and the Open Space Institute  
on behalf of Ulster County



## EXECUTIVE SUMMARY

The Open Space Institute (OSI) and Ulster County have retained the services of Barton & Loguidice, D.P.C (B&L) to assess the existing condition and propose reasonable and prudent options for the replacement or rehabilitation of the following structure located along the Catskill Mountain Railroad (CMRR) corridor:

- Boiceville Trestle over the Esopus Creek

During the period from August 26, 2011 to September 5, 2011, Hurricane Irene and Tropical Storm Lee brought heavy rainfall, strong winds and a storm surge throughout New York State that resulted in damage to portions of the CMRR corridor in Ulster County. The Boiceville Trestle was a four span structure carrying a single rail line across the Esopus Creek. The storms washed downstream two of the four spans, leaving one span in place, and another span still founded on the pier on one end with the other end resting at ground/creek level.

Upon review of conditions in the field, observed failure mechanisms and improvements necessary, the costs associated with full replacement or a combination rehabilitation / reconstruction of the existing structure are denoted below. Refer to the last two pages of this report for a detailed breakdown of specific preliminary costs for each alternative and costs for providing access to the site. Access is assumed to be provided only from the north approach (0.25 miles) due to extensive damage to the southern approach route and the travel distance required when compared to the south approach (3.0 miles) access corridor.

### Boiceville Trestle Restoration Alternatives:

#### **Alternative 1 – Full Replacement In-Kind as a 4 Span, Railroad Structure                      \$4.25 M**

This alternative includes reconstruction of a railroad bridge in the same location as the original Boiceville Trestle with the same load bearing capabilities as the existing bridge.

#### **Alternative 2 – Rehabilitation/Reconstruction as a 4 Span, Railroad Structure                      \$2.62 M**

This alternative includes the rehabilitation / reconstruction of the bridge by reusing the existing Span 1 and Span 2 girders and replacing the two washed out spans with two new 75 foot span steel girders. This alternative also carries the assumption that Span 1 and Span 2 girders can be re-used.

#### **Alternative 3 – Rehabilitation / Reconstruction as a 3 Span Railroad Structure                      \$3.05 M**

This alternative would propose to rehabilitate the bridge by reusing the existing Span 1 and Span 2 girders and the utilization of a single, 150 foot long span. This alternative also carries the assumption that Span 1 and Span 2 girders can be re-used.



## **INTRODUCTION**

Barton & Loguidice, D.P.C. (B&L) has prepared this alternative assessment and option report for the replacement or rehabilitation of the Boiceville Trestle that previously carried the Catskill Mountain Railroad (CMRR) over the Esopus Creek, in the Town of Olive. During the period from August 26, 2011 to September 5, 2011, Hurricane Irene and Tropical Storm Lee brought heavy rainfall, strong winds and a storm surge throughout New York State and resulted in damage to portions of the CMRR in Ulster County. The Boiceville Trestle was a four span structure carrying a single rail line across the Esopus Creek. The storms washed out three of the spans, leaving one span in place, two of the spans fully washed off the pier supports, and one span resting on the substructure on one end, with the other end dropped off the pier location and resting at ground/creek level.

This report will assess the feasible options for full replacement or partial reconstruction of the structure (as identified by the Open Space Institute), provide order of magnitude costs, and advantages and disadvantages of viable options such that Ulster County can effectively plan and program for the necessary funding and construction schedule timing to restore the structure at this location to working order with a long term service life.

## **DATA COLLECTION AND FIELD RECONNAISSANCE ASSESSMENT**

On Tuesday, June 24, 2014, engineers from Barton & Loguidice, D.P.C. visited the existing bridge site to confirm site conditions and take necessary photos and measurements. The information below was obtained from this site visit and will help form the basis for the recommendations to restore this rail connection.

Pre-storm, the Boiceville Trestle was a four span structure carrying light rail over the Esopus Creek. The span configuration consisted of four 73.5 foot long spans for a total length of approximately 294 feet. The superstructure consisted of a steel, two girder system supporting rails and rail ties for a single track line. The girders are comprised of plate girder construction, with an overall girder depth of approximately 74 inches. The two girders are spaced at approximately 80 inches on center. The two abutments and three piers are comprised of ashlar built-up stone construction. The approximate height of the piers and abutments from ground to bridge seat level is approximately 10 feet and the substructures measure approximately 25 feet in width at chest height, and include a 12 foot wide “recess” at the top of each substructure where the girder and track system passed through. The substructures are skewed to the superstructure at approximately 25 degrees.



Boiceville Trestle – Typical Span Configuration

The findings of the field inspection include:

- The superstructure in Span 1 remains generally intact. The structural steel in Span 1 is in fair condition with only minor surface rusting evident. There are large segments of rotted and missing railroad ties throughout Span 1.
- The Span 2 superstructure is dislodged from its support on the south end. The north end of Span 2 rests on Pier 1, while the south end of Span 2 rests on the stream bed of Esopus Creek.
- The Span 3 and Span 4 superstructures have been dislodged from the existing substructures and are currently resting, partially submerged in stream flows, along the banks of the Esopus Creek. One span rests along the north stream bank and the other span rests along the south stream bank.



Span 1 - Condition



Span 2 - Dislodged From Pier 2

- The North Abutment and Pier 1 remain generally intact and in fair condition. There are areas of dislodged stones with cracks and missing mortar between the stone courses at both substructure units. Pier 1 also exhibits signs of scour and dislodged stones mostly at the upstream pier nose and along the south face at the base of the pier stem.



Pier 1 - General Condition



Pier 1 – Scour/Dislodged Stones

- Pier 2 and Pier 3 were completely destroyed and/or washed away during the storm events and there are only small remnants of these piers that remain intact or partially salvageable at the bridge site.
- The South Abutment exhibits large areas of scour and dislodged stones. The bridge seat has completely failed and is not usable. The South Abutment would require complete re-construction under any of the bridge replacement/rehabilitation alternatives.
- The stream banks of the Esopus Creek exhibit erosion, exposed root systems, and loss of vegetation due to apparent turbulent flow, most notably along the south creek bank.



South Abutment – Dislodged Stones



South Stream Bank Erosion

- FEMA reporting suggests that all four girder spans can be re-used and this potential reuse was investigated. After our initial review, we believe that the Span 1 and 2 girders can be re-used, while the Spans 3 and 4 girders should not be re-used as follows:
  - The existing Span 1 girders have minor areas of deterioration as noted in the field. The girders are generally intact and appear to be in good condition. It is anticipated that the Span 1 girders could be reused and may require only minor repairs.
  - The existing Span 2 girders were dropped from the Pier 2 bridge seat during the storm event and their internal condition, as well as condition of all attachments and welds are unknown at this time. A 100% hands on inspection will need to be completed on the girders to properly evaluate their existing conditions in order to make a final determination as to their re-use. At this time, it is assumed the girders could be re-used because a cursory visual inspection completed in the field seems to show no significant areas of deterioration or damage as a result of the partial collapse. The existing tree branches and debris that has collected near the girder end resting in the stream bed will need to be removed and then a full inspection of the girders will be completed. It is assumed that a portion of the girder end may have been damaged and/or bent when the girders fell off the bridge seat. If so, the damaged portion of the girders could be removed and the rest of the existing girder in good condition could be re-used. We assume that the majority of the existing Span 2 girders will be able to be re-used, with only minor repairs and modifications necessary.
  - The existing Span 3 and 4 girders were dislodged from the substructures and have since been washed several hundred feet downstream. The spans have been partially covered in stream flows since the storm events and we do not feel it is prudent to reuse these girder sections given the probability that significant deterioration has likely occurred due to rust and corrosion from wet conditions. In addition, there would likely be significant costs and environmental impacts associated with moving the girder sections from where they rest along the stream banks back in place on the new substructures.



Spans 3 & 4 Dislodged



Spans 3 & 4 Washed Downstream

## **ENVIRONMENTAL CONSTRAINTS AND PERMITTING REQUIREMENTS**

B&L has performed a desktop analysis and a hands-on field view assessment of the project footprint, including the structure as it currently stands, as well as the water course below, with the following environmental points of note made:

- The Esopus Creek feeds into the Ashokan Reservoir. Within the project area, the stream is classified by the New York State Department of Environmental Conservation as Class A stream, with A(T) Standards. Class A waters are a source of water supply for drinking, food processing purposes, primary and secondary contact recreation, and fishing. The stream is also suitable for trout habitat. Based on this classification, the Esopus Creek is a protected stream in accordance with NYSDEC's Protection of Waters Program (6 NYCRR Part 608).
- The channel has sufficient width to be navigable, however, under typical flow conditions shallow openings and rocks make this stretch of the Esopus Creek only navigable by the smallest of craft such as kayaks, canoes and shallow hulled boats. If, however, the NYSDEC does determine the stream to meet state navigability criteria, an Article 15 Excavation and Fill in Navigable Waters Permit would be required for any in-stream work or disturbance.
- Federal threatened/endangered species recorded in this area include the Northern Wild monkshood (*Aconitum noveboracense*) (Threatened), Indiana bat (*Myotis sodalists*) (Endangered), Northern Long-Eared bat (*Myotis septentrionalis*) (Proposed Endangered), and Bog Turtle (*Clemmys muhlenbergii*) (Threatened). Under each Build option a habitat investigation would be required to determine whether suitable habitat for any of these species exists on site. If evidence of such species or suitable habitat is found, the addition of mitigation or avoidance measures may be required (i.e. seasonal tree removal for bats, minimizing wetland impacts, etc.).

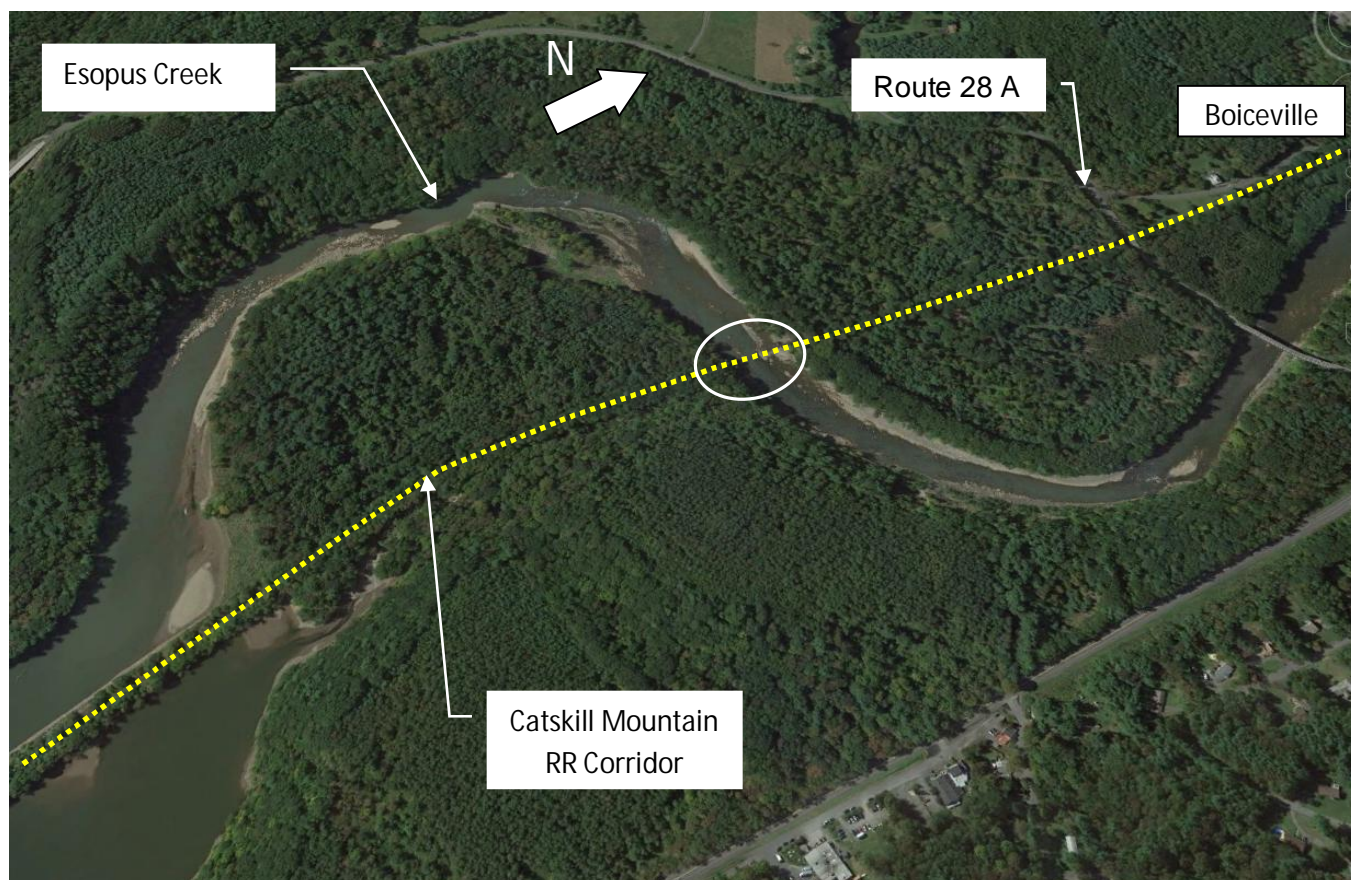

- The project site and the options investigated propose to cross the Esopus Creek located within the New York City drinking water supply watershed. Work within the watershed is regulated and permitted by the NYCDEP and NYSDEC.
- It is unclear at this time if any State or Federal protected wetlands exist adjacent to the bridge location. A wetland delineation would be completed prior to beginning work to determine if any potential impacts will occur. If required, mitigation measures will be investigated.
- The project would likely be progressed under SEQRA as an Unlisted Action.
- The bridge is not listed on the NYSDOT's 2002 National Register Eligibility study and is not recognized as being historically eligible. However, the structure is located within a potential archeologically sensitive area (according to the State Historic Preservation Office's (SHPO's) online GIS mapping). Coordination will be progressed with the SHPO during preliminary design to determine historic eligibility (if any).

- The following permits will need to be obtained, regardless of which alternative is chosen:
  - **Article 15 Stream Disturbance Permit** from NYSDEC will be required for any temporary or permanent disturbance to the bed or banks of the stream resource. In-stream timing restrictions will apply (no in-stream work allowed between October 1st and April 30<sup>th</sup> (estimated)).
  - **Article 15 Excavation and Fill in Navigable Waters Permit** from NYSDEC will be required if it is determined that the stream is navigable (see navigability discussion above).
  - **Section 401 Water Quality Certification** from NYSDEC may also apply (blanket coverage may be applicable; otherwise, individual coverage will be obtained). The need for this permit will depend upon the final scope of work.
  - Based on the potential scope of work, it appears that the project fits under the **USACE's Section 404 Nationwide #3 permit**.
  - **NYCDEP** has been contacted to discuss the potential permit requirements and the concept of constructing a temporary causeway for construction access. Preliminary indications are that the temporary causeway construction to replace the bridge is feasible and permissible.

## UTILITY REQUIREMENTS

There are no known utilities carried on or under the bridge. The field investigations found no evidence of lines, buried structures, or reports of discontinued service as a result of the failure of the structure.

## RIGHT-OF-WAY

It is likely that the majority of the work associated with structure replacement or rehabilitation can be accomplished within the existing CMRR right-of-way, however temporary easements/access agreements will be required with NYCDEP. During preliminary design, survey and mapping investigations will reveal more detailed requirements concerning Right-of-Way.

## ALTERNATIVES

The feasible alternatives for consideration for the restoration of the Boiceville Trestle are:

1. Alternative 1 – Replacement as a 4 Span, Railroad Structure
2. Alternative 2 – Rehabilitation/Reconstruction as a 4 Span, Railroad Structure
3. Alternative 3 – Rehabilitation/Reconstruction as a 3 Span Railroad Structure

Each of the alternatives is based on the assumption that the horizontal and vertical rail alignments on both approaches will be minimally modified in order to accommodate the selected replacement structure. Based on the size of the existing girders, the bridge appears to have been originally designed to a loading standard very similar to the current standard known as Cooper E-80 loading. According to the New York State Department of Transportation Bridge Manual, Section 2.6.5, “all structures carrying railroads shall be designed for Cooper E-80 loading unless noted otherwise by the owner”. Since the proposed project is to replace the damaged bridge in kind, the alternatives below are based on the assumed live load rail loading of Cooper E-80.

**Alternative 1 – 4 Span Railroad Bridge (Replacement-In-Kind):** This alternative includes reconstruction of a railroad bridge in the same location and configuration as the original Boiceville Trestle.

- Configuration – The original trestle was a four span structure and this alternative includes replacement of the structure in-kind as a four span structure. The extreme weather events from Hurricane Irene and Tropical Storm Lee and the location of the trestle piers in the middle of the stream flows likely caused floating debris to become trapped in between the piers and underneath the girders. It is likely that this limitation contributed to the catastrophic failure of the structure during the major storm events noted herein. It is recommended that the replacement structure, if this alternative is chosen, be investigated and consider a reduction the number of spans, and thus a reduction in the number of piers within the stream channel.
- Superstructure Type – The original bridge consisted of a two girder system with the railroad infrastructure carried on top of the main structural members. The depth of the existing girders is approximately 74”. The costs associated with this alternative assume that the bridge superstructure would be replaced in the same configuration, using a two girder system approximately 74” in depth, including replacement of all rails, ties, bolts, and connections as required in order to reconstruct the railroad over the new bridge. The bridge would be designed to carry a live load of Cooper E-80 loading.

Acknowledging that a hydraulic assessment and analysis has not been performed under the current scope of work, it is reasonable to assume that based on the evidence of stream bank scour and erosion, and the events contributing to the collapse of the bridge, that improvements to the hydraulic opening at this site are warranted. The existing girders appeared to have acted as a dam and relief only came after the superstructure was overtopped. The flood event placed an undue amount of lateral hydraulic pressure on the superstructure and likely resulted in the dislodging of the existing bridge girders. In this instance, and in consideration of the structural loading required under this alternative, it is reasonable to consider reducing the depth of the steel girders or design the replacement with a truss superstructure. Trusses have the advantage of allowing overtopping stream flows to “flow through” the structure with much less surface area to resist water flows when compared to the original deep girder system. Furthermore, with the majority of the truss extending above deck level, the structure depth below deck is minimized and incremental increases in hydraulic freeboard can be achieved with little vertical alignment adjustment.



- **Substructures** – The existing substructures have partially failed. Piers 2 and 3 have completely washed away and the south abutment has experienced heavy deterioration to a point where it is no longer capable of carrying live loads or supporting a superstructure. Pier 1 shows signs of scour at the footing and various deteriorated areas in the form of cracks and missing stones/mortar along the pier faces. Under this alternative, the existing substructures would be fully removed and replaced. This alternative assumes two abutments and three piers will be constructed of cast-in-place concrete founded on piles driven to sound bedrock. To emulate the original construction, consideration could be given to the use of form liners that mirror the ashlar rock construction of the original bridge.
- **Access** – Providing access for the transport of equipment and materials to and from the bridge site is a key component of this project and is one that does not appear to be addressed in the record documents reviewed. The closest trail access point to the north of the existing bridge is approximately 0.25 miles and the closest access point to the south is 3.0 miles away from the bridge. In order to gain access to the rail bed at the north, the most reasonable approach to access would be to construct a temporary access road originating from NY Route 28A. The temporary access road would be approximately 18' feet wide to support the load of heavy equipment and accommodate the transport of [wide load] structural steel and components. Construction of the temporary access road would require extensive tree and brush clearing, which could also require additional coordination with NYSDEC for the necessary permits.

At the south end of the bridge, there does not appear to be a reasonable way to construct an access road between the rail bed and NY Route 28. The elevation of NY Route 28 is 100-200 feet above the elevation of the rail bed and the area between Route 28 and the rail bed is a densely wooded forest.

The only feasible option to provide access to the bridge is from the north. Where the proposed temporary access road meets with the existing rail bed, it is proposed to place approximately 1 foot of crushed stone on top of the existing rails in order to provide a surface on which construction vehicles can travel. The crushed stone base will be placed at the beginning of construction and will be removed once construction is completed. In order to facilitate construction from the north approach only, a temporary causeway 150 to 175 feet in length would be constructed beginning near the north abutment and extending out into the stream to allow for construction vehicle movement and transport of materials near the center of the stream. Given the overall length of the bridge and the limitation of access only from the north, the causeway would need to extend 30 to 40 feet beyond the center of the stream. The causeway would be surrounded by cofferdams on both sides, likely concrete barriers or sand bags placed on the bottom of the stream bed and wrapped in silt fence. Inside the cofferdams, the causeway would be constructed of embankment material and stone in order to provide an access road for construction vehicles and equipment. At the end of the causeway, near the center of the creek, a closed cell sheet pile cofferdam would need to be constructed to provide a location to build a crane pad and set up a crane to be used for lifting of the temporary bridge and replacement bridge spans. A sequencing of events to allow for construction is included as Appendix A.

**Alternative 2 – 4 Span Railroad Bridge (Rehabilitation/Reconstruction):** This alternative would propose to rehabilitate a portion of the bridge by reusing the existing Span 1 and Span 2 girders and replacing the two washed out spans with two (2) new 75 foot span steel girders girder spans.

- Configuration – The configuration of this alternative would match the existing bridge in that there would be four, equal spans, each measuring approximately 75 feet in length.
- Superstructure Type – Under this alternative, the existing Span 1 girders will remain in place and be re-used. The existing Span 2 girders will be removed from their current location while pier construction/repairs are completed and then reset in their existing location upon completion of the repairs to Pier 1 and replacement of Pier 2. Two new 75 foot span girder sections would be placed for Span 3 and Span 4 and would utilize a similar configuration to the two-girder system of the existing bridge. The bridge reconstruction under this alternative would also include replacement of all rails, ties, bolts, and connections as required in order to reconstruct the railroad over the new bridge. The new Span 3 and Span 4 girders would be designed to carry Cooper E-80 rail loading. Based on preliminary design investigations, the new girders would be of similar cross sectional area and similar dimensions to the existing girders, which is indicative that the existing girders were once designed for freight rail loading. According to the NYS Bridge Manual, unless otherwise noted, all new railroad structures shall be designed to carry Cooper E-80 loading. Similar to Alternative 1, the design of this alternative would also consider a truss type superstructure for the replacement of Span 3 and Span 4 in order to reduce the superstructure depth and improve the hydraulics of the bridge crossing.
- Substructures – The proposed substructures under this alternative would include reuse of the existing North Abutment and Pier 1, and construction of a new Pier 2, Pier 3, and South Abutment. The repairs to the North Abutment and Pier 1 would include re-pointing of the mortar joints between the laid up stones and construction of a protective concrete plinth wall around the base of Pier 1 in order to repair the existing scour and undermining conditions and to protect the pier from future scour and undermining. The substructures to be replaced (Pier 2, Pier 3, South Abutment), would be cast-in-place concrete substructures founded on piles driven to sound rock. To emulate the original construction, consideration could be given to the use of form liners that mirror the ashlar rock construction of the original bridge.
- Access – All access activities required to complete this alternative are the same as described in Alternative 1.

**Alternative 3 – 3 Span Railroad Bridge (Rehabilitation/Reconstruction):** This alternative would propose to rehabilitate a portion of the bridge by reusing the existing Span 1 and Span 2 girders and the utilization of a single, 150 foot long span.

- Configuration – The configuration of this alternative would be a three span bridge, with the two existing 75 foot long spans reused. Span 1 would likely remain in its current location and the

salvaged Span 2 would be re-located to the south abutment. A new 150 foot span would be constructed in the center of the bridge.

- **Superstructure** – Two options have been investigated for the superstructure of the new 150 foot long center span of the bridge. The first option would include construction of a new 150 foot long two-girder superstructure that would utilize a similar configuration to the existing bridge spans. Preliminary design shows that a 150 foot span girder section capable of carrying Cooper E-80 loading would need to be approximately 15 feet deep, as compared to the existing girders that are approximately 6 feet deep. This increase in girder depth would result in a significant reduction to the hydraulic opening provided by the bridge, which likely would not be acceptable to the regulatory agencies and would not be recommended given the failure mode of the existing structure. Also investigated was the possibility of utilizing a built up steel truss structure for the new 150 foot span. Preliminary investigations indicate that a truss structure at a span length of 150 feet, designed to carry Cooper E-80 loading would be a very large above deck truss and would likely be cost prohibitive when compared to the other Alternatives presented herein.
- **Substructures** – The proposed substructures under this alternative would include reuse of the existing North Abutment and Pier 1, and construction of a new Pier 2, and South Abutment. The repairs to the North Abutment and Pier 1 would include re-pointing of the mortar joints between the laid up stones and construction of a protective concrete plinth wall around the base of Pier 1 in order to repair the existing scour and undermining conditions and to protect the pier from future scour and undermining. The substructures to be replaced (Pier 2, South Abutment), would be cast-in-place concrete substructures founded on piles driven to sound rock. To emulate the original construction, consideration could be given to the use of form liners that mirror the ashlar rock construction of the original bridge.
- **Access** – All access activities required to complete this alternative are the same as described in Alternative 1.

## **ALTERNATIVE COST ESTIMATES**

A detailed preliminary estimate of the costs associated with each replacement or rehabilitation alternative is included below. Costs were based on information found in the FEMA Project Worksheet, “Backup Documents”, “CEF Documents”, and engineering judgment.

It is our understanding that reconstruction of the Boiceville Trestle will be completed in advance of repairs or improvements on both approaches of the bridge. All access costs associated with physically getting construction vehicles to the site are calculated and/or assumed in the following cost estimates. Construction access is proposed to be provided from the north only. The implementation of this is contingent upon the ability to construct a causeway in the Esopus Creek and the securing of the required permits. Preliminary discussions with NYCDEP indicate that this will be feasible.

<b>RAILROAD STRUCTURE</b>			
<b>Bridge Costs</b>			
<b>Task</b>	<b>Alternative 1 Replacement 4 Span Bridge</b>	<b>Alternative 2 Rehabilitation 4 Span Bridge</b>	<b>Alternative 3 Rehabilitation 3 Span Bridge</b>
Remove Existing Substructures and Superstructure*	\$250,000	\$50,000	\$50,000
Repairs to Existing Substructures	-	\$ 40,000	\$ 40,000
New Substructures	\$830,000	\$ 510,000	\$ 360,000
New Steel Girders	\$1,400,000	\$ 500,000	\$1,100,000
New Rail and Ties Across Bridge	\$75,000	\$75,000	\$75,000
Temporary Bracing/Resetting of Existing Span 2 Girders	-	\$20,000	\$30,000
<b>Bridge Costs</b>	<b>\$2,555,000</b>	<b>\$ 1,195,000</b>	<b>\$ 1,655,000</b>
<b>Access Costs</b>			
<b>Task</b>	<b>Alternative 1 Replacement 4 Span Bridge</b>	<b>Alternative 2 Rehabilitation 4 Span Bridge</b>	<b>Alternative 3 Rehabilitation 3 Span Bridge</b>
Clearing & Temporary Road (North Approach)	\$200,000	\$200,000	\$200,000
Causeway (In-Stream Access)	\$310,000	\$310,000	\$310,000
Subbase Placement/Removal at North Approach for Construction Vehicles	\$75,000	\$ 75,000	\$ 75,000
Cofferdam for Crane Pad	\$100,000	\$100,000	\$100,000

<b>RAILROAD STRUCTURE</b>			
Cofferdam for Piers	\$200,000	\$200,000	\$100,000
Temporary Bridge (1 – 75' span)	\$75,000	\$ 75,000	\$ 75,000
Modifications to Existing South Abutment for Temp. Bridge	\$25,000	\$ 25,000	\$ 25,000
<b>Total Access Costs</b>	<b>\$985,000</b>	<b>\$ 985,000</b>	<b>\$ 885,000</b>
<b>Access &amp; Bridge Costs</b>	<b>\$3,540,000</b>	<b>\$ 2,180,000</b>	<b>\$ 2,540,000</b>
<b>Contingency (20%)</b>	<b>\$710,000</b>	<b>\$ 440,000</b>	<b>\$ 510,000</b>
<b>Alternative 1 Project Cost (2014)</b>	<b>\$4,250,000</b>	<b>\$ 2,620,000</b>	<b>\$ 3,050,000</b>

\*The cost does not include removal of the two steel girder spans that are currently located downstream partially embedded along the stream banks with debris and sediment. If it is determined through regulatory agency coordination that these spans need to be removed, the estimated cost is an additional \$400,000 regardless of the Alternative chosen. It is likely that each span will need to be sectioned by cutting and disassembled in their current positions and transported off site. Temporary cofferdams and access would need to be provided to complete the removal work. A one time aerial extraction of an entire steel girder was investigated, however, was dismissed due to the added weight of sediment and debris, and the forces required to remove the embedded sections when combined are too great for this type of extraction. Aerial removal of smaller sections once cut apart could be feasible.

## **APPENDIX A**

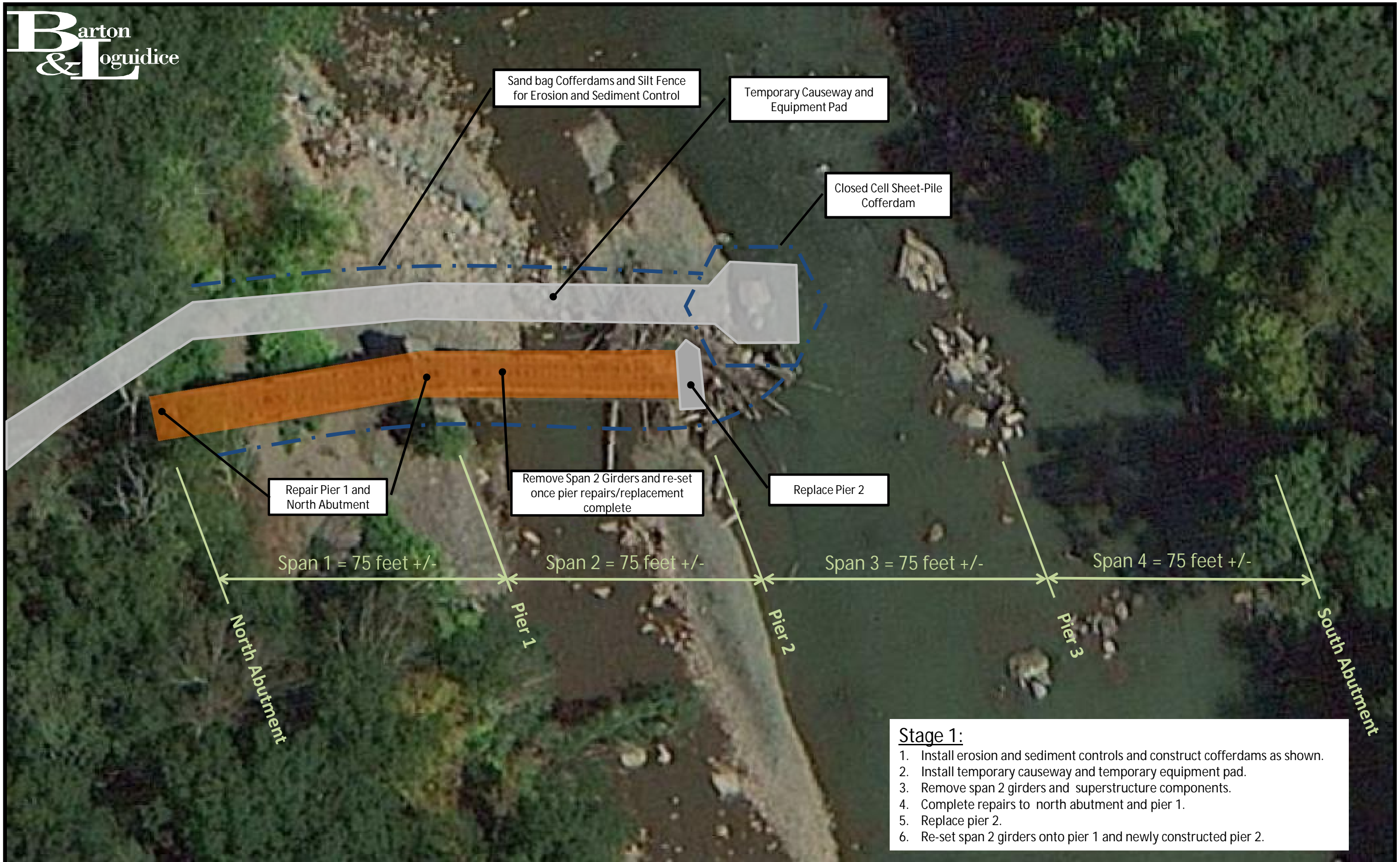

- Stage 1:**
1. Install erosion and sediment controls and construct cofferdams as shown.
  2. Install temporary causeway and temporary equipment pad.
  3. Remove span 2 girders and superstructure components.
  4. Complete repairs to north abutment and pier 1.
  5. Replace pier 2.
  6. Re-set span 2 girders onto pier 1 and newly constructed pier 2.

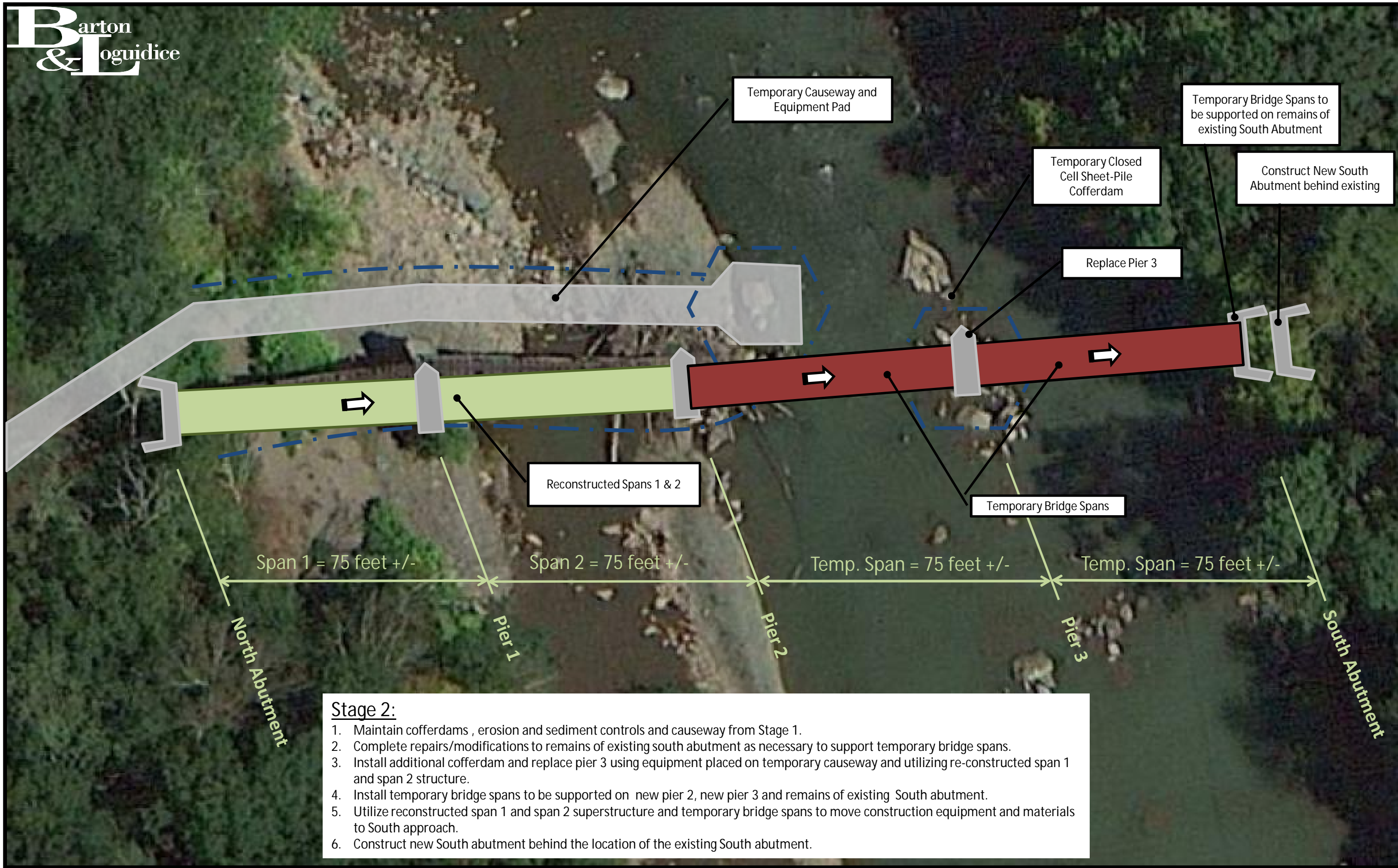

- Stage 2:**
1. Maintain cofferdams , erosion and sediment controls and causeway from Stage 1.
  2. Complete repairs/modifications to remains of existing south abutment as necessary to support temporary bridge spans.
  3. Install additional cofferdam and replace pier 3 using equipment placed on temporary causeway and utilizing re-constructed span 1 and span 2 structure.
  4. Install temporary bridge spans to be supported on new pier 2, new pier 3 and remains of existing South abutment.
  5. Utilize reconstructed span 1 and span 2 superstructure and temporary bridge spans to move construction equipment and materials to South approach.
  6. Construct new South abutment behind the location of the existing South abutment.



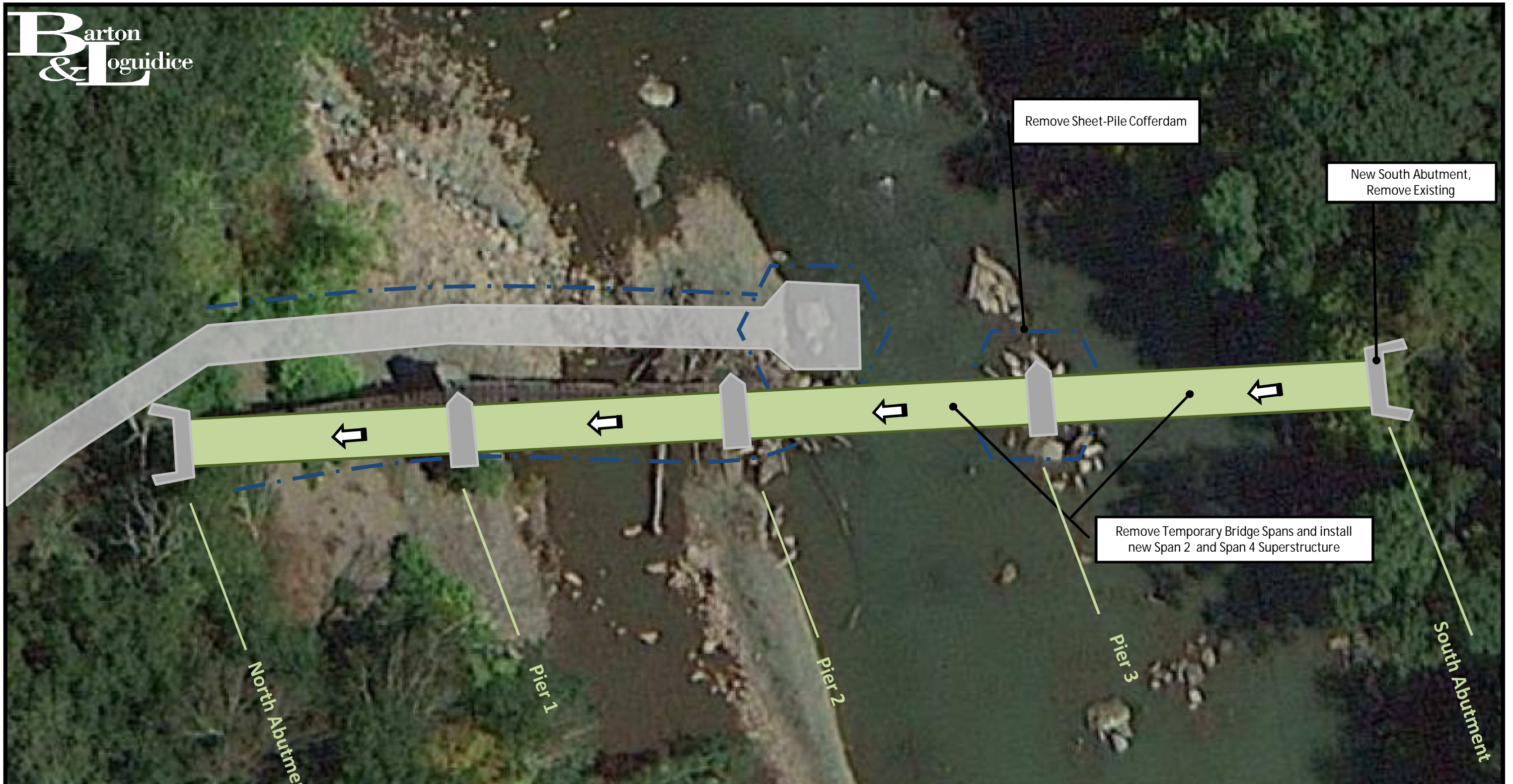

- Stage 3:**
1. Maintain cofferdams , erosion and sediment controls and causeway from Stage 1.
  2. Remove existing temporary bridge spans.
  3. Remove existing South Abutment. Store excavated materials on South approach.
  4. Install new span 3 and span 4 superstructure using equipment placed on temporary causeway and equipment pad.
  5. Remove equipment and stored materials from South approach.



**Stage 4:**

1. Remove equipment pad, causeway, cofferdams and erosion and sediment controls.
2. Complete site restoration as necessary.

## **Appendix E**

### **Butternut Cove Assessment**

# Alternative Assessment and Option Report

## Butternut Cove Large Culvert over Butternut Creek

Town of Olive  
Ulster County, New York



December 2014



## **EXECUTIVE SUMMARY**

The Open Space Institute (OSI) and Ulster County have retained the services of Barton & Loguidice, D.P.C (B&L) to assess the existing condition and propose reasonable and prudent options for the repair/restoration/replacement of the following structure located along the Catskill Mountain Rail Trail (CMRT):

- Butternut Cove Large Culvert Structure carrying the CMRR over Butternut Creek

The Butternut Cove Large Culvert Structure had originally carried the CMRR over Butternut Creek, however, heavy storm flows have resulted in the loss of the wingwall structures on the downstream outlet of the culvert. Additionally, internal shifting/settlement and separation in the barrel of the culvert has occurred causing cracks and severe deterioration of the culvert.

Upon review of the conditions in the field, observed failure mechanisms and improvements necessary, the costs associated with replacement of the existing culvert structure are listed below. Note that the costs contained within this report are based on the assumption that the work required at the Butternut Creek Culvert will be performed as a stand alone project and not in conjunction with any other work or projects.

### **Butternut Cove Large Culvert Structure**

- |  |             |
|--|-------------|
| 1. Replacement in-kind with a Light Use Railroad Structure         | \$1,200,000 |
| 2. Replacement as a Trail Bridge, Carrying Pedestrian Loading Only | \$1,100,000 |

## INTRODUCTION

Barton & Loguidice, D.P.C. (B&L) is pleased to submit this Alternative Assessment and Option Report for the Butternut Cove Large Culvert Structure carrying the Catskill Mountain Railroad (CMRR) over Butternut Creek, in the Town of Olive, New York. Heavy storm flows have resulted in loss of foundation material below the downstream end of the culvert. Erosion and scour has caused the wingwalls to completely separate from the culvert structure and tip over into the center of the creek. The loss of foundation material has also caused internal shifting/settlement and separation in the barrel of the culvert.

This report will assess the feasible options for replacement/rehabilitation of the structure (as identified by the Open Space Institute), provide order of magnitude costs, and advantages and disadvantages of viable options such that Ulster County can effectively plan and program for the necessary funding, and construction schedule timing to restore the crossing at this location with a long term service life.

## DATA COLLECTION AND FIELD RECONNAISSANCE ASSESSMENT

On Tuesday, June 24, 2014, structural engineers from Barton & Loguidice, D.P.C. visited the culvert site to assess site conditions and take necessary photos and measurements in order to form the basis for the recommendations necessary to replace the culvert.

The Butternut Cove Large Culvert Structure is a single barrel, concrete arch culvert, with a span of approximately 11.5 feet, a height of approximately 12.5 feet, and an overall width of approximately 65 feet from inlet to outlet. From the base of the culvert (stream bed) to the top of rail is approximately 25 feet.



Butternut Cove Large Culvert – General Configuration

The findings of the field inspection include:

- The upstream wingwalls and concrete arch barrel exhibit varying degrees of map cracking and efflorescence, however, the overall condition of the concrete appears in fair condition.
- Twenty feet from the downstream end of the culvert there is a 6 inch crack through the culvert, inside the culvert barrel. It appears that the downstream section of the culvert is rotating away from the adjacent portion of the culvert as evidenced by the fact that the crack widens along the top of the arch. The crack exists along the top, bottom, and both sides of the culvert and is likely caused by the loss of foundation material below the downstream end of the culvert. This is indicative of a scour and undermining condition, usually from excessive and swift flows.
- Both downstream wingwalls have rotated so as to completely separate from the culvert and are currently resting in the middle of the stream. The rotation is indicative of scour or loss of supporting foundation material and is likely caused by high stream flows exiting the structure and scouring away the stream below the downstream portion of the culvert and wingwalls.



Crack in Culvert Barrel



Downstream Wingwall Failure

- There is a large scour hole in the creekbed at the downstream end of the culvert. The scour hole results in a drop of more than four feet from the invert of the culvert barrel to the streambed elevation. The scour hole extends underneath the culvert base slab for a significant length that could not be determined in the field. It is assumed that this scour and loss of foundation material resulted in the downstream wingwall failure and cracking/rotation of the culvert barrel.
- There is evidence of on-going erosion and/or complete sloughing failure of the rail bed embankment for approximately 75 feet centered about the culvert and up to the full height of the embankment.



Scour at DS End of Culvert

Erosion/Failure of Rail Embankment

## **ENVIRONMENTAL CONSTRAINTS AND PERMITTING REQUIREMENTS**

B&L has performed a desktop analysis and a hands-on field view assessment of the project footprint, including the structure and stream, with the following environmental points of note made:

- The Butternut Creek feeds into the Ashokan Reservoir. Within the project area, the stream is also classified by the New York State Department of Environmental Conservation as Class A stream, with A(T) standards. The Butternut Creek is also a protected stream in accordance with NYSDEC's Protection of Waters Program (6 NYCRR Part 608).
- The Butternut Creek is assumed to be a non-navigable body of water. The creek upstream of the culvert is very narrow and shallow under normal stream flows. The New York State Department of Environmental Conservation (NYSDEC) would be consulted during final design to provide an official classification. If NYSDEC determines the stream to meet state navigability criteria, an Article 15 Excavation and Fill in Navigable Waters Permit would be required for any in-stream work or disturbance.
- Federal threatened/endangered species recorded in this area include the Northern Wild monkshood (*Aconitum noveboracense*) (Threatened), Indiana bat (*Myotis sodalists*) (Endangered), Northern Long-Eared bat (*Myotis septentrionalis*) (Proposed Endangered), and Bog Turtle (*Clemmys muhlenbergii*) (Threatened). A habitat investigation would be required to determine whether suitable habitat for any of these species exists on site and within any proposed limits of work. If evidence of such species or suitable habitats is found, the addition of mitigation or avoidance measures may be required (i.e. seasonal tree removal for bats, etc.).
- It is unclear at this time if any State or Federal protected wetlands exist within the potential project limits.. A wetland delineation would be completed prior to beginning work to determine if any impacts could occur. Depending on the direction design takes, mitigation measures may be necessary.



- The SEQRA action will be based on the scope of work; however, a Type II Action or Unlisted Action is most likely.
- The culvert is not listed on the NYSDOT's 2002 National Register Eligibility study and is not recognized as being historically eligible. However, the structure is located within a potential archeologically sensitive area (according to the State Historic Preservation Office's (SHPO's) online GIS mapping). The downstream face of the culvert includes a date stamp which also may suggest the structure has some historic significance even though the structure is not specifically listed as historic on the NYSDOT Register. Coordination will be progressed with SHPO during preliminary design to gain a final determination of the historic eligibility of the structure.
- Based on the premise of culvert replacement, the following permitting will be required:
  - **Article 15 Stream Disturbance Permit** from NYSDEC will be required for any temporary or permanent disturbance to the bed or banks of the stream resource. In-stream timing restrictions will apply (no in-stream work will be allowed between October 1st and April 30<sup>th</sup>), however, if a couple weeks on either side of this timeframe becomes required, a variance can be requested.
  - **Article 15 Excavation and Fill in Navigable Waters Permit** from NYSDEC if work is performed in the creek, and if the creek is determined to be navigable (see navigability discussion above).
  - A **Section 401 Water Quality Certification** from NYSDEC may also apply (blanket coverage may be applicable; otherwise, individual coverage will be obtained). The need for this permit will depend upon the final scope of work.
  - Based on the potential scope of work, it appears that the project fits under the **USACE's Section 404 Nationwide #3 permit**.
  - **NYCDEP** will be contacted during preliminary design to discuss any other potential permit requirements that should be addressed by the proposed work.

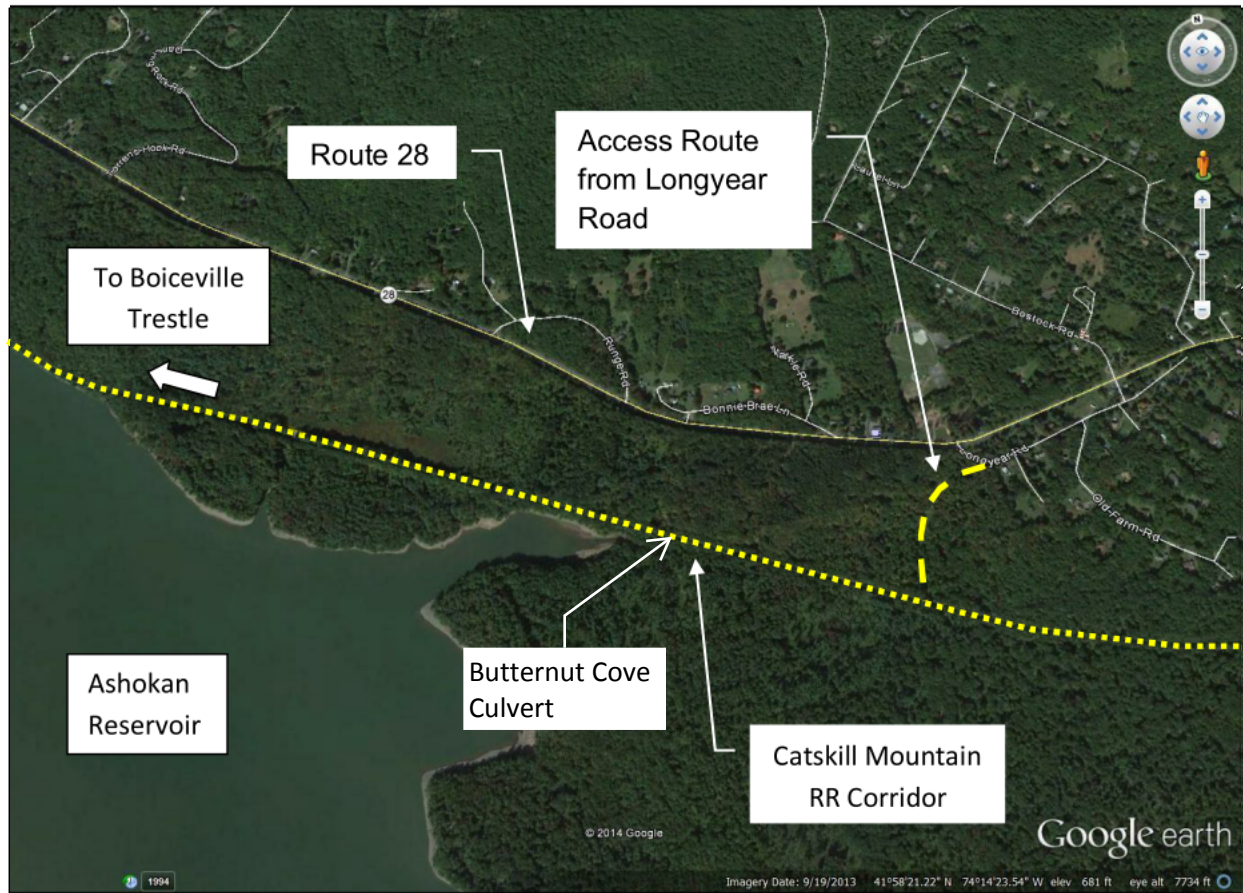

## UTILITY REQUIREMENTS

There are no utilities carried on or under the structure based on the lack of field evidence of overhead or underground lines.

## RIGHT-OF-WAY

It is likely that the majority of the work associated with the chosen alternative can be accomplished within the existing railway right-of-way, however temporary easements/access agreements will be required with the New York State Department of Environmental Protection (NYCDEP). During preliminary design, survey and mapping investigations will reveal more detailed information concerning right-of-way.

## ALTERNATIVES

The alternatives for consideration for the replacement of the Butternut Cove Large Culvert over Butternut Creek are:

1. Alternative 1 – Light Rail Structure (Replacement-In-Kind)
2. Alternative 2 – Pedestrian Bicycle Structure
3. Alternative 3 – Combined Light Rail and Pedestrian Structure
4. Alternative 4 - Rehabilitation

Each of the alternatives are based on the assumption that the horizontal and vertical trail/rail alignments on both approaches will be minimally modified in order to accommodate the selected replacement structure.

**Alternative 1 – Light Rail Structure (Replacement-In-Kind):** This alternative includes reconstruction of a light rail bridge in the same location as the original large culvert.

- Structure Type – The new culvert would likely be a three-sided concrete rigid frame with a proposed clear span of 11’-6” and a proposed rise from bottom of structure legs to the top of the culvert of 12’-6” to match the existing span and rise dimensions. The use of a three-sided rigid frame would improve upon the current arch shaped opening by providing a greater open area for stream flows to pass through. The overall width of the culvert would be approximately 65 feet to match existing. The three-sided frame would be founded upon bedrock, or deep foundations (piles). Given the existing scour and erosion at the downstream face of the culvert, and subsequent shifting and rotation of the downstream portion of the culvert, it is likely that the existing culvert is not founded on either bedrock or piles. Geotechnical investigations will be completed during preliminary design to determine the proper foundation needs.
- Access – Providing access for the transport of equipment and materials to and from the culvert is a key component of this project and is one that does not appear to be addressed by FEMA in the record documents. The closest trail access point to the north of the existing culvert would be by use of the Boiceville Trestle, which may or may not be constructed at the time the Butternut Creek Culvert is to be replaced. The closest access point to the south is by way of a trail connection on Longyear Road. This connection point is approximately 0.9 miles south of the Butternut Creek Culvert. It is proposed to use the trail connection from Longyear Road as the access point for construction vehicles and equipment to use to gain access to the culvert. This would require the placement of subbase along the rail corridor to allow the construction vehicles a solid surface on which to travel. Approximately 12” of subbase would be placed along the rail bed and rail ballast. Upon completion of the culvert reconstruction, the subbase would then need to be removed if the corridor were to remain for light rail use.

**Alternative 2 – Pedestrian/Bicycle Structure:** This alternative would include replacing the culvert over Butternut Creek with a culvert designed for use as a pedestrian/bicycle structure.

- Structure Type – The new culvert would have a similar configuration and similar dimensions to the structure as described in Alternative 1. The hydraulic opening/capacity of the structure would be maximized to the greatest extent possible to allow for design stream flows to pass through the culvert structure.
- Access – As noted above in Alternative 1, providing access to the culvert location is a key component of this project. The methods of providing access for this alternative are the same as the methods noted in Alternative 1, with the exception that the subbase used to provide an access road for construction vehicles would not need to be removed upon completion of the culvert replacement. Under this alternative, the trail would be used for pedestrian and bicyclist use. The subbase is proposed to be left in place and would function as the base for the trail system. Upon completion, the portion of trail from the Butternut Culvert to the Longyear Road trail connection would be nearly ready for placement of the final trail surface, whether it be stone dust or asphalt.

**Alternative 3 – Combined Light Rail and Pedestrian Structure:** This alternative would provide for a structure designed to accommodate light rail and pedestrian traffic, both in geometrical configuration and in loading.

- The superstructure type would need to consider the placement of pedestrian traffic alongside an active rail line. Positive separation and protection would be required. The overall width of the culvert would need to be increased to accommodate both modes of transportation at the structure.
- The trail approaches on both sides of the bridge have existing rail ties from the former railroad. If a new stretch of trail were to be constructed to allow pedestrians to walk alongside of the light rail, care would need to be exercised to provide enough separation between the two areas to keep the pedestrians safe. The trail segments on either approach appear to be wide enough to carry one type of usage, but not both. Significant costs and environmental impacts would be required to construct a new trail segment along the already existing railroad bed in order to carry both light rail and pedestrian traffic.

Based on the need to carry a dual system along the entire corridor, and the significant impacts that would occur at the approaches, it is deemed that this alternative is not fiscally or environmentally prudent and is recommended to be discarded from further consideration.

**Alternative 4 – Rehabilitation:** This alternative would provide for a rehabilitated culvert structure. During the site visit by B&L personnel, a 100% hands-on inspection was completed to determine the extent of existing deterioration. Given the widespread deterioration and the type of deterioration that exists, it is not recommended to consider rehabilitation as a feasible alternative going forward. The loss of foundation material at the downstream end of the culvert has caused significant cracking and separation between adjacent culvert pieces and has caused the downstream wingwalls to completely fail. Rotation of the downstream culvert pieces has also caused heavy erosion along the rail bed on top of the

culvert. It is not feasible or prudent to try to replace the foundation material at the downstream end of the culvert given the unknowns about the existing foundation. Given the difficulties and unknowns of the existing foundations, it is determined that this alternative is not prudent to be further investigated and is discarded from further discussion.

### **ALTERNATIVE COST ESTIMATES**

The cost of replacement of the Butternut Creek Culvert is based on the New York State Department of Transportation's (NYSDOT) "Preliminary Cost Estimate Worksheet (New and Replacement Bridges). This methodology accounts for the historical cost data collected by NYSDOT for similar work, in similar regions, under similar conditions. At this stage of analysis, we typically find these numbers to be conservative in nature and suitable for programming purposes. Note that the costs listed below are based on the assumption that the replacement of the Butternut Creek Culvert will be completed separately from either the Boiceville Trestle reconstruction or construction of any other projects in the area. Some economies of scale could be realized if specific portions of this projected are completed concurrently.

<b>ALTERNATIVE 1 – LIGHT RAIL STRUCTURE</b>	
<b>Culvert Costs</b>	
<b>Task</b>	<b>Cost</b>
Removal of Existing Culvert	\$ 75,000
Cofferdams/Dewatering Equipment	\$ 25,000
New Culvert Structure	\$ 750,000
Engineering, Survey, Borings	\$ 85,000
<b>Subtotal Culvert Costs</b>	<b>\$ 935,000</b>
<b>Access Costs</b>	
Clearing & Grubbing	\$ 25,000
Methods of Access along Existing Rails	\$ 100,000
Rail Restoration	N/A
<b>Subtotal Access Costs</b>	<b>\$ 125,000</b>
<b>Totals</b>	
<b>Culvert + Access Costs</b>	<b>\$ 1,060,000</b>
<b>Contingency (15%)</b>	<b>\$ 160,000</b>
<b>Estimated Project Costs (2015 dollars)</b>	<b>\$ 1,200,000</b>

<b>ALTERNATIVE 2 – PEDESTRIAN/BICYCLE STRUCTURE</b>	
<b>Culvert Costs</b>	
<b>Task</b>	<b>Cost</b>
Removal of Existing Culvert	\$ 75,000
Cofferdams/Dewatering Equipment	\$ 25,000
New Culvert Structure	\$ 725,000
Engineering, Survey, Borings	\$ 75,000
<b>Subtotal Culvert Costs</b>	<b>\$ 900,000</b>
<b>Access Costs</b>	
Clearing & Grubbing	\$ 15,000
Methods of Access along Existing Rails	\$ 60,000
<b>Subtotal Access Costs</b>	<b>\$ 75,000</b>
<b>Totals</b>	
<b>Culvert + Access Costs</b>	<b>\$ 975,000</b>
<b>Contingency (+/- 20 %)</b>	<b>\$ 175,000</b>
<b>Estimated Project Costs (2015 dollars)</b>	<b>\$ 1,100,000</b>

**Appendix F**  
**Environmental**



*Celebrating over 50 years of service*

October 28, 2014

Information Services  
Natural Heritage Program  
New York State Department of Environmental Conservation  
625 Broadway, 5<sup>th</sup> Floor  
Albany, New York 12233-4757

**Re:** Catskill Mountain Rail Trail  
Town of Hurley and Town of Olive, Ulster County, New York

**Subj:** Request for Information

**File:** 1653.002.001

Dear Sir or Madam:

Barton & Loguidice, D.P.C. (B&L) has been retained by the Open Space Institute for preliminary design services concerning the Catskill Mountain Rail Trail Project. The project consists of an 11.5 mile long rail corridor extending from NY Route 28A in the Town of Olive to Basin Road in the Town of Hurley, Ulster County. The trail will follow the former Catskill Mountain Rail Road tracks between these termini, located just north of the Ashokan Reservoir. The project would include the removal of the steel rails and wooden ties, re-grading of existing stone ballast, installation of new stone subbase, asphalt pavement, pedestrian/bicycle railing, and various drainage improvements to support a multi-use path for pedestrians and bicyclists. Construction activities will take place on or immediately adjacent to the existing railroad embankment.

B&L is currently conducting environmental screenings of the project site and this documentation is being provided to initiate the NYSDEC's review of endangered and threatened species for this project. We ask for your determination if there are records of state listed (or proposed for inclusion) endangered or threatened species in the vicinity of the project area.

Enclosed is a project location map. The western terminus of the rail corridor is approximately located at the coordinates 42.003403° N latitude and 74.269960° W longitude, midpoint at 41.974551° N latitude and 74.197927° W longitude, and eastern terminus at 41.993213° N latitude and 74.088739° W longitude.

Thank you for your assistance with this project.

Very truly yours,

BARTON & LOGUIDICE, D.P.C.

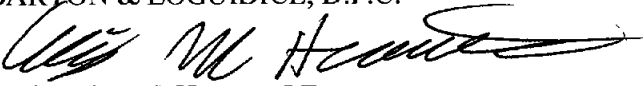

Christopher M. Hannett, I.E.  
Engineer II

CMH/tms  
Enclosures



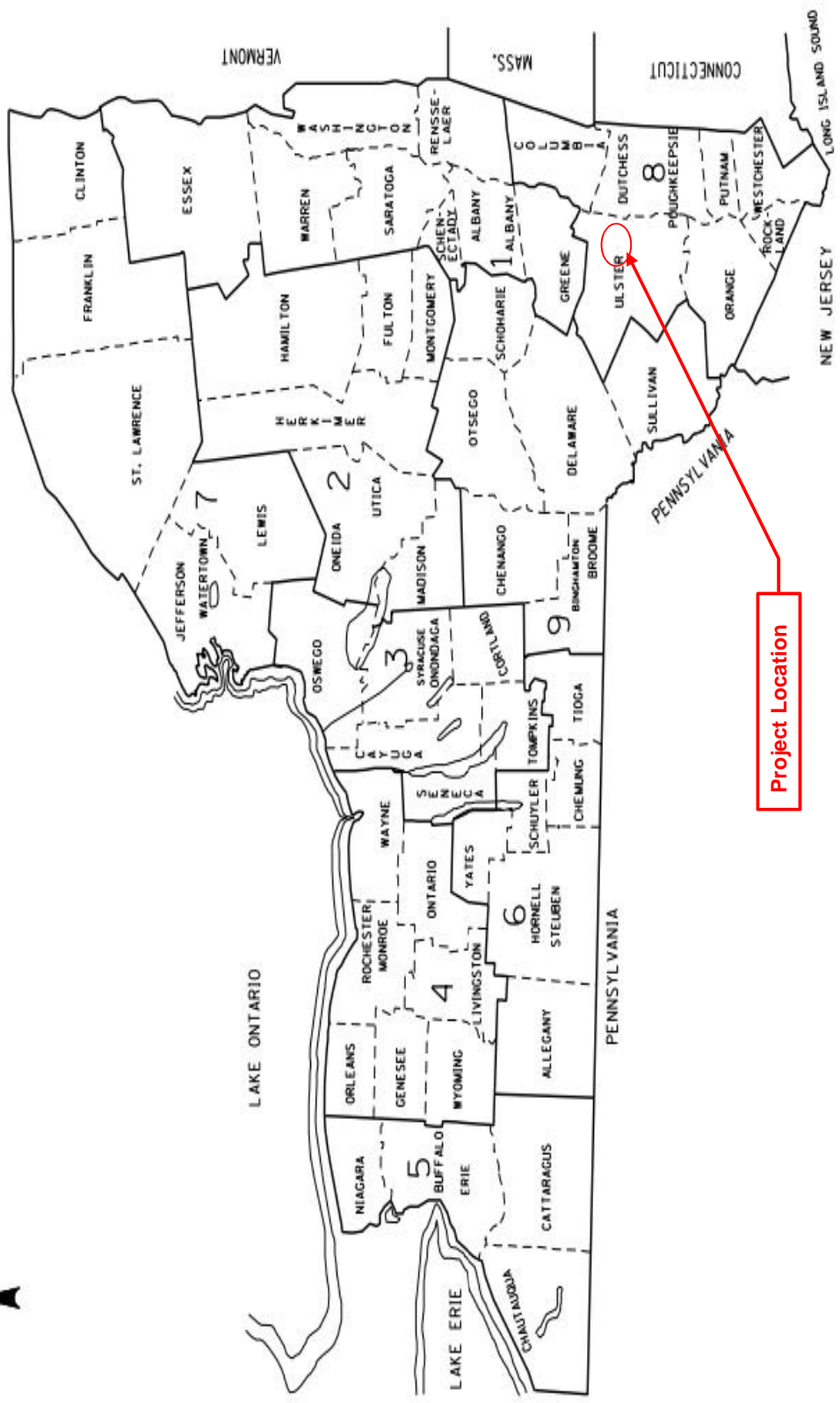

Town of Olive and Town of Hurley, Ulster County, New York

**Figure 1 - Regional Location Map  
Catskill Mountain Rail Trail**



Source: Google Maps

October 2014

Engineers • Environmental Scientists • Planners • Landscape Architects

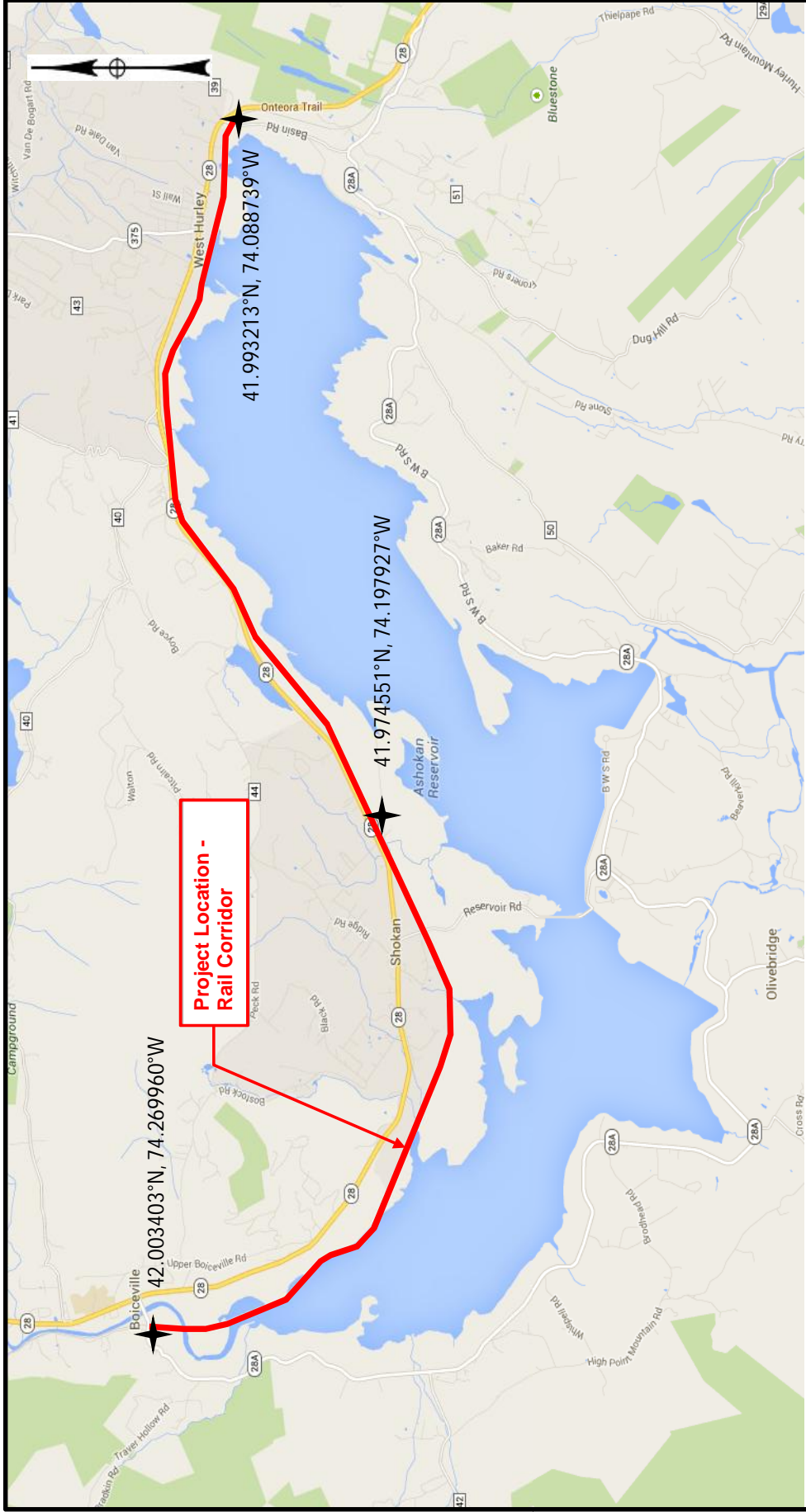

Town of Olive and Town of Hurley, Ulster County, New York

**Figure 2 - Project location Map  
Catskill Mountain Rail Trail**



Source: Google Maps

October 2014

Engineers • Environmental Scientists • Planners • Landscape Architects

**NEW YORK STATE DEPARTMENT OF ENVIRONMENTAL CONSERVATION**  
**Division of Fish, Wildlife & Marine Resources**  
**New York Natural Heritage Program**  
625 Broadway, 5<sup>th</sup> Floor, Albany, New York 12233-4757  
**Phone:** (518) 402-8935 • **Fax:** (518) 402-8925  
**Website:** [www.dec.ny.gov](http://www.dec.ny.gov)



Joe Martens  
Commissioner

November 26, 2014

Christopher Hannett  
Barton & Loguidice, D.P.C.  
10 Airline Drive, Suite 200  
Albany, NY 12205

Re: Catskill Mountain Rail Trail (File: 1653.002.001)  
Town/City: Hurley, Olive. County: Ulster.

Dear Christopher Hannett :

In response to your recent request, we have reviewed the New York Natural Heritage Program database with respect to the above project.

Enclosed is a report of rare or state-listed animals and plants, and significant natural communities, which our databases indicate occur, or may occur, on your site or in the immediate vicinity of your site.

For most sites, comprehensive field surveys have not been conducted; the enclosed report only includes records from our databases. We cannot provide a definitive statement as to the presence or absence of all rare or state-listed species or significant natural communities. Depending on the nature of the project and the conditions at the project site, further information from on-site surveys or other sources may be required to fully assess impacts on biological resources.

Our databases are continually growing as records are added and updated. If this proposed project is still under development one year from now, we recommend that you contact us again so that we may update this response with the most current information.

The presence of the plants and animals identified in the enclosed report may result in this project requiring additional review or permit conditions. For further guidance, and for information regarding other permits that may be required under state law for regulated areas or activities (e.g., regulated wetlands), please contact the appropriate NYS DEC Regional Office, Division of Environmental Permits, as listed at [www.dec.ny.gov/about/39381.html](http://www.dec.ny.gov/about/39381.html).

Sincerely,

Andrea Chaloux  
Environmental Review Specialist  
New York Natural Heritage Program



**The following state-listed animals have been documented at your project site, or in its vicinity.**

The following list includes animals that are listed by NYS as Endangered, Threatened, or Special Concern; and/or that are federally listed or are candidates for federal listing. The list may also include significant natural communities that can serve as habitat for Endangered or Threatened animals, and/or other rare animals and rare plants found at these habitats.

**For information about potential impacts of your project on these populations, how to avoid, minimize, or mitigate any impacts, and any permit considerations, contact the Wildlife Manager or the Fisheries Manager at the NYSDEC Regional Office for the region where the project is located. A listing of Regional Offices is at <http://www.dec.ny.gov/about/558.html>.**

**The following species have been documented within 0.1 mi of the project site. Individual animals may travel 1 mi from documented locations.**

<i>COMMON NAME</i>	<i>SCIENTIFIC NAME</i>	<i>NY STATE LISTING</i>	<i>FEDERAL LISTING</i>
<b>Birds</b>			
<b>Bald Eagle</b> <i>Breeding</i>	<i>Haliaeetus leucocephalus</i>	Threatened	10989

**The following species have been documented within 2.5 mi of the project site. Individual animals may travel 2.5 mi from documented locations.**

<i>COMMON NAME</i>	<i>SCIENTIFIC NAME</i>	<i>NY STATE LISTING</i>	<i>FEDERAL LISTING</i>
<b>Mammals</b>			
<b>Indiana Bat</b> <i>Maternity colony</i>	<i>Myotis sodalis</i>	Endangered	Endangered 11652

This report only includes records from the NY Natural Heritage databases. For most sites, comprehensive field surveys have not been conducted, and we cannot provide a definitive statement as to the presence or absence of all rare or state-listed species. Depending on the nature of the project and the conditions at the project site, further information from on-site surveys or other sources may be required to fully assess impacts on biological resources.

If any rare plants or animals are documented during site visits, we request that information on the observations be provided to the New York Natural Heritage Program so that we may update our database.

Information about many of the listed animals in New York, including habitat, biology, identification, conservation, and management, are available online in Natural Heritage’s Conservation Guides at [www.guides.nynhp.org](http://www.guides.nynhp.org), and from NYSDEC at [www.dec.ny.gov/animals/7494.html](http://www.dec.ny.gov/animals/7494.html).



**The following rare plants, rare animals, and significant natural communities have been documented at your project site, or in its vicinity.**

We recommend that potential onsite and offsite impacts of the proposed project on these species or communities be addressed as part of any environmental assessment or review conducted as part of the planning, permitting and approval process, such as reviews conducted under SEQR. Field surveys of the project site may be necessary to determine the status of a species at the site, particularly for sites that are currently undeveloped and may still contain suitable habitat. Final requirements of the project to avoid, minimize, or mitigate potential impacts are determined by the lead permitting agency or the government body approving the project.

**The following significant natural communities are considered significant from a statewide perspective by the NY Natural Heritage Program. They are either occurrences of a community type that is rare in the state, or a high quality example of a more common community type. By meeting specific, documented criteria, the NY Natural Heritage Program considers these community occurrences to have high ecological and conservation value.**

<i>COMMON NAME</i>	<i>SCIENTIFIC NAME</i>	<i>NY STATE LISTING</i>	<i>HERITAGE CONSERVATION STATUS</i>
--------------------	------------------------	-------------------------	-------------------------------------

**Wetland/Aquatic Communities**

**Vernal Pool**

High Quality Occurrence of Uncommon Community Type

Bluestone: This is a moderate size vernal pool complex in good condition within a large natural landscape in very good condition.

13052

This report only includes records from the NY Natural Heritage databases. For most sites, comprehensive field surveys have not been conducted, and we cannot provide a definitive statement as to the presence or absence of all rare or state-listed species. Depending on the nature of the project and the conditions at the project site, further information from on-site surveys or other sources may be required to fully assess impacts on biological resources.

If any rare plants or animals are documented during site visits, we request that information on the observations be provided to the New York Natural Heritage Program so that we may update our database.

Information about many of the rare animals and plants in New York, including habitat, biology, identification, conservation, and management, are available online in Natural Heritage's Conservation Guides at [www.guides.nynhp.org](http://www.guides.nynhp.org), from NatureServe Explorer at [www.natureserve.org/explorer](http://www.natureserve.org/explorer), and from USDA's Plants Database at <http://plants.usda.gov/index.html> (for plants).

Information about many of the natural community types in New York, including identification, dominant and characteristic vegetation, distribution, conservation, and management, is available online in Natural Heritage's Conservation Guides at [www.guides.nynhp.org](http://www.guides.nynhp.org). For descriptions of all community types, go to [www.dec.ny.gov/animals/97703.html](http://www.dec.ny.gov/animals/97703.html) for Ecological Communities of New York State.



## United States Department of the Interior



FISH AND WILDLIFE SERVICE  
New York Ecological Services Field Office  
3817 LUKER ROAD  
CORTLAND, NY 13045  
PHONE: (607)753-9334 FAX: (607)753-9699  
URL: [www.fws.gov/northeast/nyfo/es/section7.htm](http://www.fws.gov/northeast/nyfo/es/section7.htm)

Consultation Tracking Number: 05E1NY00-2015-SLI-0099

October 27, 2014

Project Name: Catskill Mountain Rail Trail

Subject: List of threatened and endangered species that may occur in your proposed project location, and/or may be affected by your proposed project.

### To Whom It May Concern:

The enclosed species list identifies threatened, endangered, proposed and candidate species, as well as proposed and final designated critical habitat, that may occur within the boundary of your proposed project and/or may be affected by your proposed project. The species list fulfills the requirements of the U.S. Fish and Wildlife Service (Service) under section 7(c) of the Endangered Species Act (ESA) of 1973, as amended (16 U.S.C. 1531 *et seq.*). This list can also be used to determine whether listed species may be present for projects without federal agency involvement. New information based on updated surveys, changes in the abundance and distribution of species, changed habitat conditions, or other factors could change this list.

Please feel free to contact us if you need more current information or assistance regarding the potential impacts to federally proposed, listed, and candidate species and federally designated and proposed critical habitat. Please note that under 50 CFR 402.12(e) of the regulations implementing section 7 of the ESA, the accuracy of this species list should be verified after 90 days. This verification can be completed formally or informally as desired. The Service recommends that verification be completed by visiting the ECOS-IPaC site at regular intervals during project planning and implementation for updates to species lists and information. An updated list may be requested through the ECOS-IPaC system by completing the same process used to receive the enclosed list. If listed, proposed, or candidate species were identified as potentially occurring in the project area, coordination with our office is encouraged. Information on the steps involved with assessing potential impacts from projects can be found at: <http://www.fws.gov/northeast/nyfo/es/section7.htm>

Please be aware that bald and golden eagles are protected under the Bald and Golden Eagle Protection Act (16 U.S.C. 668 *et seq.*), and projects affecting these species may require development of an eagle conservation plan ([http://www.fws.gov/windenergy/eagle\\_guidance.html](http://www.fws.gov/windenergy/eagle_guidance.html)). Additionally, wind energy projects

should follow the Services wind energy guidelines (<http://www.fws.gov/windenergy/>) for minimizing impacts to migratory birds and bats.

Guidance for minimizing impacts to migratory birds for projects including communications towers (e.g., cellular, digital television, radio, and emergency broadcast) can be found at: <http://www.fws.gov/migratorybirds/CurrentBirdIssues/Hazards/towers/towers.htm>; <http://www.towerkill.com>; and <http://www.fws.gov/migratorybirds/CurrentBirdIssues/Hazards/towers/comtow.html>.

We appreciate your concern for threatened and endangered species. The Service encourages Federal agencies to include conservation of threatened and endangered species into their project planning to further the purposes of the ESA. Please include the Consultation Tracking Number in the header of this letter with any request for consultation or correspondence about your project that you submit to our office.

Attachment





United States Department of Interior  
Fish and Wildlife Service

Project name: Catskill Mountain Rail Trail

## Official Species List

### Provided by:

New York Ecological Services Field Office

3817 LUKER ROAD

CORTLAND, NY 13045

(607) 753-9334

<http://www.fws.gov/northeast/nyfo/es/section7.htm>

**Consultation Tracking Number:** 05E1NY00-2015-SLI-0099

**Project Type:** Recreation Construction / Maintenance

**Project Description:** This project will convert the existing Catskill Mountain Rail Road tracks and embankment into a multi-use trail



United States Department of Interior  
Fish and Wildlife Service

Project name: Catskill Mountain Rail Trail

### Project Location Map:



**Project Coordinates:** MULTIPOLYGON (((-74.2705207 41.9968865, -74.2705635 41.9959653, -74.2703077 41.995094, -74.2693864 41.9935964, -74.2693857 41.9935952, -74.2661353 41.9873928, -74.265783 41.9868532, -74.2654098 41.9864886, -74.264649 41.9858833, -74.2625839 41.9842982, -74.2604558 41.98272, -74.2604535 41.982718, -74.2595317 41.9817877, -74.2595281 41.9817827, -74.2587747 41.9803031, -74.2587741 41.9803019, -74.2583186 41.9792484, -74.257873 41.9786298, -74.2571167 41.9778995, -74.2548986 41.9762824, -74.2541819 41.9759484, -74.2528955 41.9754219, -74.232017 41.9683232, -74.2294436 41.9675578, -74.227256 41.9671689, -74.224211 41.9669616, -74.2216817 41.9670318, -74.2184008 41.9673506, -74.2153347 41.9680839, -74.2123104 41.9691525, -74.1988996 41.9743372, -74.1988995 41.9743372, -74.1840938 41.9799363, -74.1840936 41.9799364, -74.1803821 41.9813079, -74.1790859 41.9818901, -74.1776708 41.9825914, -74.1762555 41.9834361, -74.1667073 41.9897359, -74.1667059 41.9897368, -74.1654935 41.9903987, -74.165492 41.9903994, -74.1639363 41.9910852, -74.1639349 41.9910858, -74.1601265 41.9924332, -74.1582286 41.9931744, -74.1569212 41.9938274, -74.1552165 41.9948554, -



United States Department of Interior  
Fish and Wildlife Service

Project name: Catskill Mountain Rail Trail

74.1509249 41.9978133, -74.1509237 41.997814, -74.1497865 41.9984837, -74.1497848  
41.9984847, -74.1477463 41.9994255, -74.1477426 41.9994268, -74.1458114 41.9998893, -  
74.1458094 41.9998896, -74.1425913 42.0003201, -74.14259 42.0003202, -74.129908 42.0012284,  
-74.1299067 42.0012285, -74.1277824 42.0012444, -74.1277808 42.0012443, -74.1259418  
42.0011072, -74.1259385 42.0011067, -74.1248163 42.0008292, -74.1248144 42.0008286, -  
74.1227014 42.000072, -74.1227009 42.0000718, -74.1159538 41.9974492, -74.1137241  
41.9969552, -74.1046061 41.9953459, -74.1046059 41.9953458, -74.1007218 41.9946075, -  
74.098234 41.994217, -74.0961111 41.9940975, -74.0922367 41.9940409, -74.0922359  
41.9940409, -74.0910574 41.9939779, -74.0910554 41.9939777, -74.0905029 41.99389, -  
74.090501 41.9938896, -74.0898511 41.9937215, -74.0898491 41.9937208, -74.0891839  
41.9934736, -74.0891818 41.9934727, -74.0887366 41.9932455, -74.0887305 41.9932407, -  
74.0887267 41.9932339, -74.0887258 41.9932261, -74.0887279 41.9932186, -74.0887327  
41.9932125, -74.0887395 41.9932087, -74.0887473 41.9932078, -74.0887548 41.9932099, -  
74.089199 41.9934366, -74.0898621 41.993683, -74.0905101 41.9938506, -74.0910606 41.993938,  
-74.0922377 41.9940009, -74.0961121 41.9940575, -74.0961129 41.9940575, -74.0982372  
41.9941771, -74.0982392 41.9941773, -74.1007283 41.994568, -74.1007289 41.9945682, -  
74.1046132 41.9953065, -74.1137315 41.9969159, -74.1137323 41.9969161, -74.1159639  
41.9974105, -74.1159668 41.9974114, -74.1227151 42.0000345, -74.1248269 42.0007906, -  
74.1259465 42.0010675, -74.127783 42.0012044, -74.1299058 42.0011885, -74.1425866  
42.0002804, -74.145803 41.9998501, -74.1477313 41.9993883, -74.1497671 41.9984488, -  
74.1509028 41.9977799, -74.1551944 41.9948221, -74.1551954 41.9948215, -74.1569013  
41.9937928, -74.1569027 41.993792, -74.1582116 41.9931382, -74.1582132 41.9931375, -  
74.1601122 41.9923959, -74.1601128 41.9923956, -74.1639208 41.9910483, -74.1654751  
41.9903631, -74.166686 41.989702, -74.1762339 41.9834025, -74.1762346 41.983402, -  
74.1776509 41.9825566, -74.1776523 41.9825559, -74.1790685 41.9818541, -74.1790692  
41.9818538, -74.1803663 41.9812712, -74.1803676 41.9812706, -74.1840797 41.9798989, -  
74.1988853 41.9742998, -74.2122963 41.969115, -74.2122968 41.9691148, -74.2153223  
41.9680458, -74.2153243 41.9680452, -74.2183928 41.9673113, -74.2183956 41.9673109, -  
74.2216786 41.9669919, -74.2216799 41.9669918, -74.2242108 41.9669216, -74.2242128  
41.9669216, -74.2272598 41.967129, -74.2272619 41.9671293, -74.2294517 41.9675186, -  
74.2294539 41.9675191, -74.2320288 41.9682849, -74.2320295 41.9682852, -74.2529089  
41.9753843, -74.2529101 41.9753847, -74.2541975 41.9759116, -74.2541983 41.975912, -  
74.2549172 41.976247, -74.2549206 41.9762489, -74.2571414 41.977868, -74.2571435  
41.9778698, -74.2579021 41.9786023, -74.2579044 41.978605, -74.2583523 41.9792268, -  
74.2583545 41.9792306, -74.2588106 41.9802855, -74.2595623 41.9817617, -74.2604808



United States Department of Interior  
Fish and Wildlife Service

Project name: Catskill Mountain Rail Trail

41.9826887, -74.2626078 41.9842661, -74.2626081 41.9842663, -74.2646735 41.9858516, -  
74.2646738 41.9858519, -74.2654355 41.986458, -74.265437 41.9864593, -74.2658125  
41.9868261, -74.2658152 41.9868295, -74.2661693 41.9873718, -74.2661703 41.9873734, -  
74.2694208 41.993576, -74.2703431 41.9950753, -74.2703453 41.9950802, -74.2706028  
41.9959573, -74.2706036 41.9959638, -74.2705607 41.9968887, -74.2705606 41.9968894, -  
74.2700456 42.0033795, -74.2700435 42.003387, -74.2700387 42.0033931, -74.2700319  
42.0033969, -74.2700241 42.0033978, -74.2700166 42.0033957, -74.2700105 42.0033909, -  
74.2700067 42.0033841, -74.2700058 42.0033763, -74.2705207 41.9968865)))

**Project Counties:** Ulster, NY



United States Department of Interior  
Fish and Wildlife Service

Project name: Catskill Mountain Rail Trail

## Endangered Species Act Species List

There are a total of 3 threatened or endangered species on your species list. Species on this list should be considered in an effects analysis for your project and could include species that exist in another geographic area. For example, certain fish may appear on the species list because a project could affect downstream species. Critical habitats listed under the **Has Critical Habitat** column may or may not lie within your project area. See the **Critical habitats within your project area** section further below for critical habitat that lies within your project. Please contact the designated FWS office if you have questions.

Mammals	Status	Has Critical Habitat	Condition(s)
Indiana bat ( <i>Myotis sodalis</i> ) Population: Entire	Endangered		
northern long-eared Bat ( <i>Myotis septentrionalis</i> )	Proposed Endangered		
<b>Reptiles</b>			
Bog Turtle ( <i>Clemmys muhlenbergii</i> ) Population: northern	Threatened		



United States Department of Interior  
Fish and Wildlife Service

Project name: Catskill Mountain Rail Trail

## **Critical habitats that lie within your project area**

There are no critical habitats within your project area.

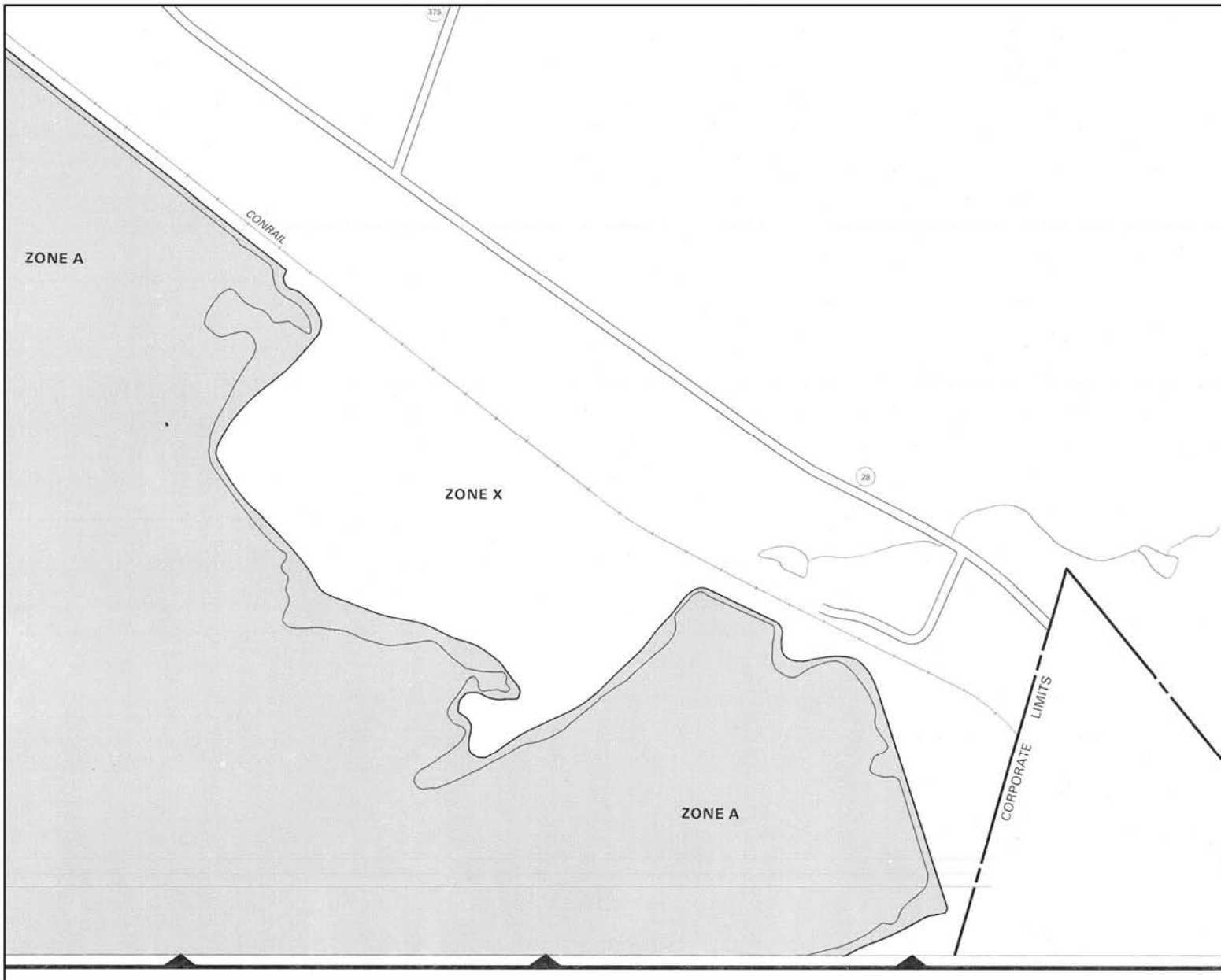

**LEGEND**







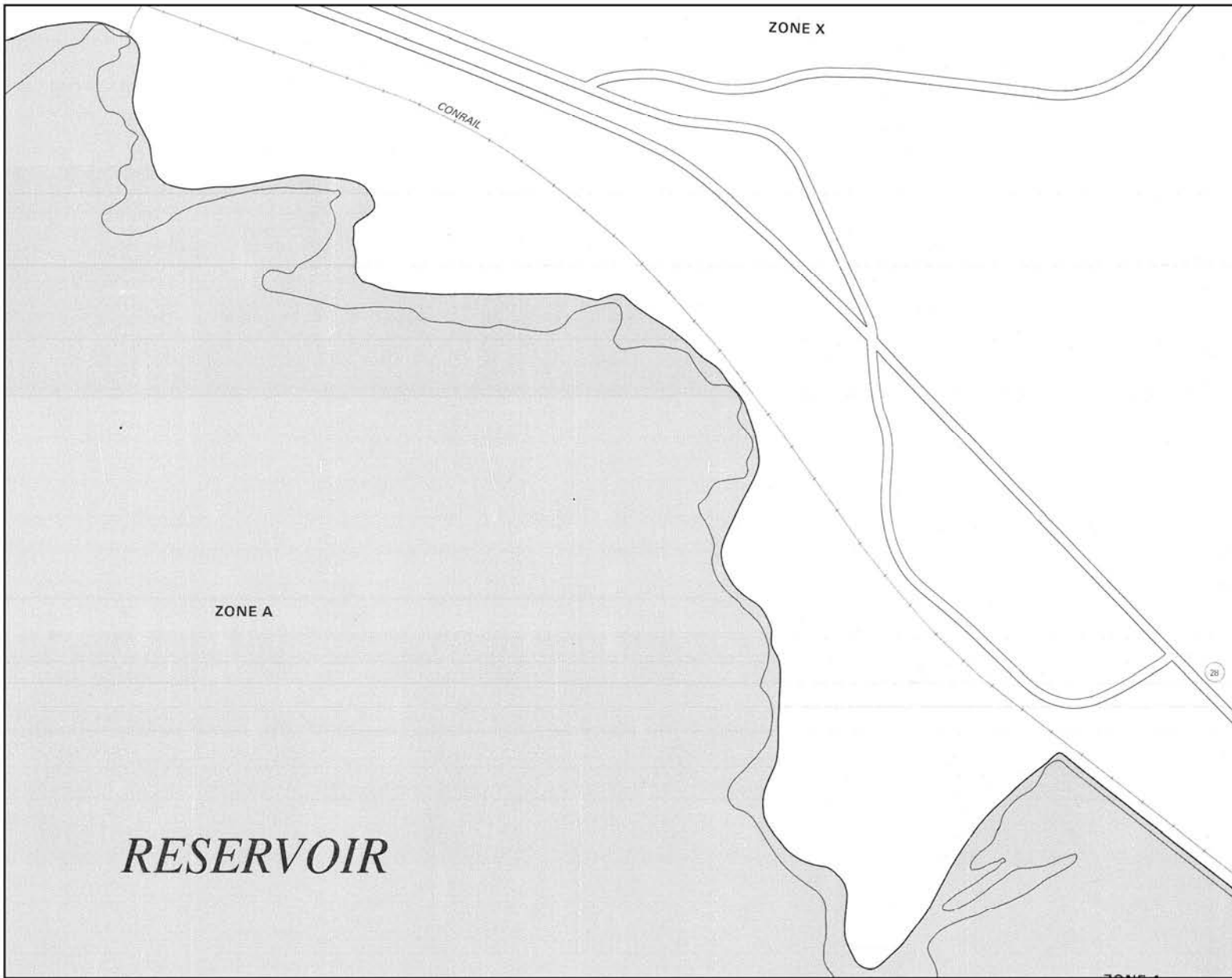





- SPECIAL FLOOD HAZARD AREAS INUNDATED BY 100-YEAR FLOOD
- ZONE A** - no base flood elevations determined.
- ZONE AE** - Base flood elevations determined.
- ZONE AH** - Flood depths of 1 to 3 feet (usually areas of ponding); base flood elevations determined.
- ZONE AO** - Flood depths of 1 to 3 feet (usually sheet flow on sloping terrain); average depths determined; for areas of abutment (e.g. flooding); velocities also determined.
- ZONE APF** - To be protected from 100-year flood by Federal flood protection system under construction; no base flood elevations determined.
- ZONE V** - Coastal flood with velocity hazard (wave action); no base flood elevations determined.
- ZONE VE** - Coastal flood with velocity hazard (wave action); base flood elevations determined.
- FLOODWAY AREAS IN ZONE AE
- OTHER FLOOD AREAS**
- ZONE X** - Area of 100-year flood; areas of 100-year flood with average depths of less than 1 foot or with drainage area less than 1 square mile and areas protected by levees from 100-year flood.
- OTHER AREAS**
- ZONE D** - Areas determined to be outside 100-year floodplains.
- ZONE U** - Areas in which flood hazards are undetermined.
- UNDEVELOPED COASTAL BARRIERS
- Floodplain Boundary
- Floodway Boundary
- Zone D Boundary
- Boundary Dividing Special Flood Hazard Zones, and Boundary Dividing Areas of Different Coastal Base Flood Elevations Within Special Flood Hazard Zones.
- Base Flood Elevation Line; Elevation in Feet\*
- Cross Section Line
- Base Flood Elevation in Feet Where Unders Wides Zone\*
- Elevation Reference Mark
- MSL Aisle

**NOTES**

This is an official copy of a portion of the above referenced flood map. It was extracted using F-MIT On-Line. This map does not reflect changes or amendments which may have been made subsequent to the date on the title block. For the latest product information about National Flood Insurance Program flood maps check the FEMA Flood Map Store at [www.msc.fema.gov](http://www.msc.fema.gov)



**LEGEND**

-  SPECIAL FLOOD HAZARD AREAS INUNDATED BY 100-YEAR FLOOD
- ZONE A** — no base flood elevations determined.
- ZONE AE** — Base flood elevations determined.
- ZONE AH** — Flood depths of 1 to 3 feet (usually sheet flow or ponding); base flood elevations determined.
- ZONE AO** — Flood depths of 1 to 3 feet (usually sheet flow on sloping terrain); average depths determined. For areas of abutment, flooding velocities also determined.
- ZONE APB** — To be protected from 100-year flood by Federal flood protection system under construction; no base flood elevations determined.
- ZONE V** — Coastal flood with velocity hazard (wave action); no base flood elevations determined.
- ZONE VE** — Coastal flood with velocity hazard (wave action); base flood elevations determined.
-  FLOODWAY AREAS IN ZONE AE
- OTHER FLOOD AREAS**
- ZONE X** — Area of 100-year flood; area of 100-year flood with average depths of less than 1 foot or with drainage area less than 1 square mile and areas protected by levees from 100-year flood.
- OTHER AREAS**
- ZONE X** — Areas determined to be outside 100-year floodplain.
- ZONE D** — Areas in which flood hazards are undetermined.
-  UNDEVELOPED COASTAL BARRIERS
-  Floodplain Boundary
-  Floodway Boundary
-  Zone D Boundary
-  Boundary Dividing Special Flood Hazard Zones, and Boundary Dividing Areas of Different Coastal Base Flood Elevations Within Special Flood Hazard Zones.
-  Base Flood Elevation Line; Elevation in Feet\*
-  Cross Section Line
-  Base Flood Depth in Feet Where Unders Wides Zone\*
-  Elevation Reference Mark
-  Mile Mark

\*Referenced to the National Geodetic Vertical Datum of 1929

**NOTES**

This is an official copy of a portion of the above referenced flood map. It was extracted using F-MIT On-Line. This map does not reflect changes or amendments which may have been made subsequent to the date on the title block. For the latest product information about National Flood Insurance Program flood maps check the FEMA Flood Map Store at [www.msc.fema.gov](http://www.msc.fema.gov)

ZONE A



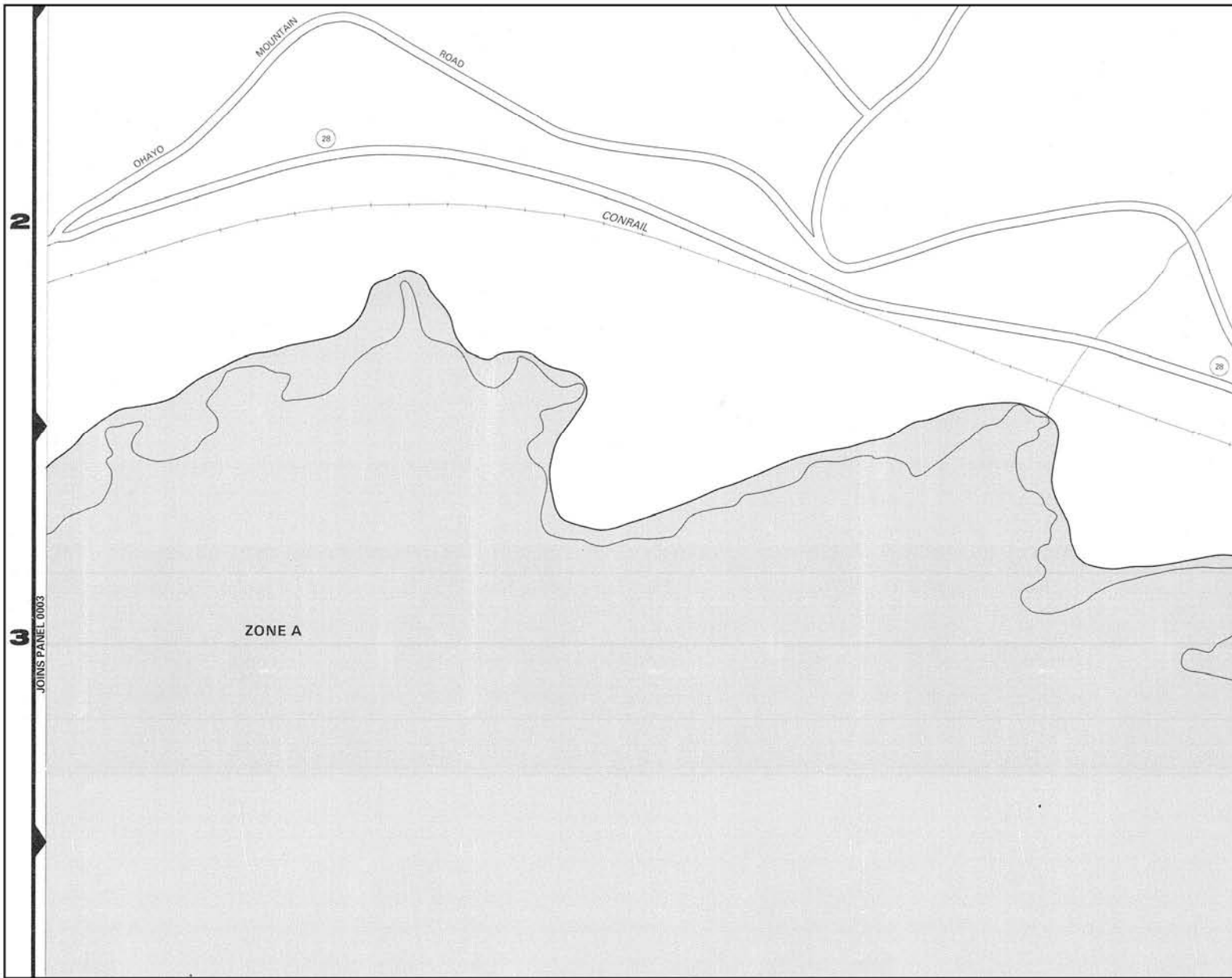

**LEGEND**

- SPECIAL FLOOD HAZARD AREAS INUNDATED BY 100-YEAR FLOOD
- ZONE A** - No base flood elevations determined.
- ZONE AE** - Base flood elevations determined.
- ZONE AH** - Flood depths of 3 to 3 feet (usually areas of ponding); base flood elevations determined.
- ZONE AD** - Flood depths of 1 to 3 feet (usually those flow on sloping terrain; average depth determined for areas of littoral fan flooding; velocities also determined).
- ZONE A99** - To be protected from 100-year flood by Federal flood protection system under construction; no base flood elevations determined.
- ZONE V** - Coastal flood with velocity hazard (wave action); no base flood elevations determined.
- ZONE VE** - Coastal flood with velocity hazard (wave action); base flood elevations determined.
- FLOODWAY AREAS IN ZONE AE
- OTHER FLOOD AREAS**
- ZONE X** - Areas of 500-year flood; areas of 100-year flood with average depths of less than 1 foot or with drainage area less than 1 square mile; and areas protected by levees from 100-year flood.
- OTHER AREAS**
- ZONE X** - Areas determined to be outside 500-year floodplain.
- ZONE D** - Areas in which flood hazards are undetermined.
- UNDEVELOPED COASTAL BARRIERS
- Floodplain Boundary
- Floodway Boundary
- Zone D Boundary
- Boundary Dividing Special Flood Hazard Zones, and Boundary Dividing Area of Concern Coastal Base Flood Elevations Within Special Flood Hazard Zones.
- Base Flood Elevation (see Elevation in Feet)\*
- Cross Section Line
- Base Flood Elevation in Feet Where Uniform Water Zone\*
- Elevation Reference Mark
- Kilo Mile

\*Referenced to the National Geodetic Vertical Datum of 1929

**NOTES**

This is an official copy of a portion of the above referenced flood map. It was extracted using F-MIT On-Line. This map does not reflect changes or amendments which may have been made subsequent to the date on the title block. For the latest product information about National Flood Insurance Program flood maps check the FEMA Flood Map Store at [www.msc.fema.gov](http://www.msc.fema.gov)

N  
W  
JOINS PANEL 0003

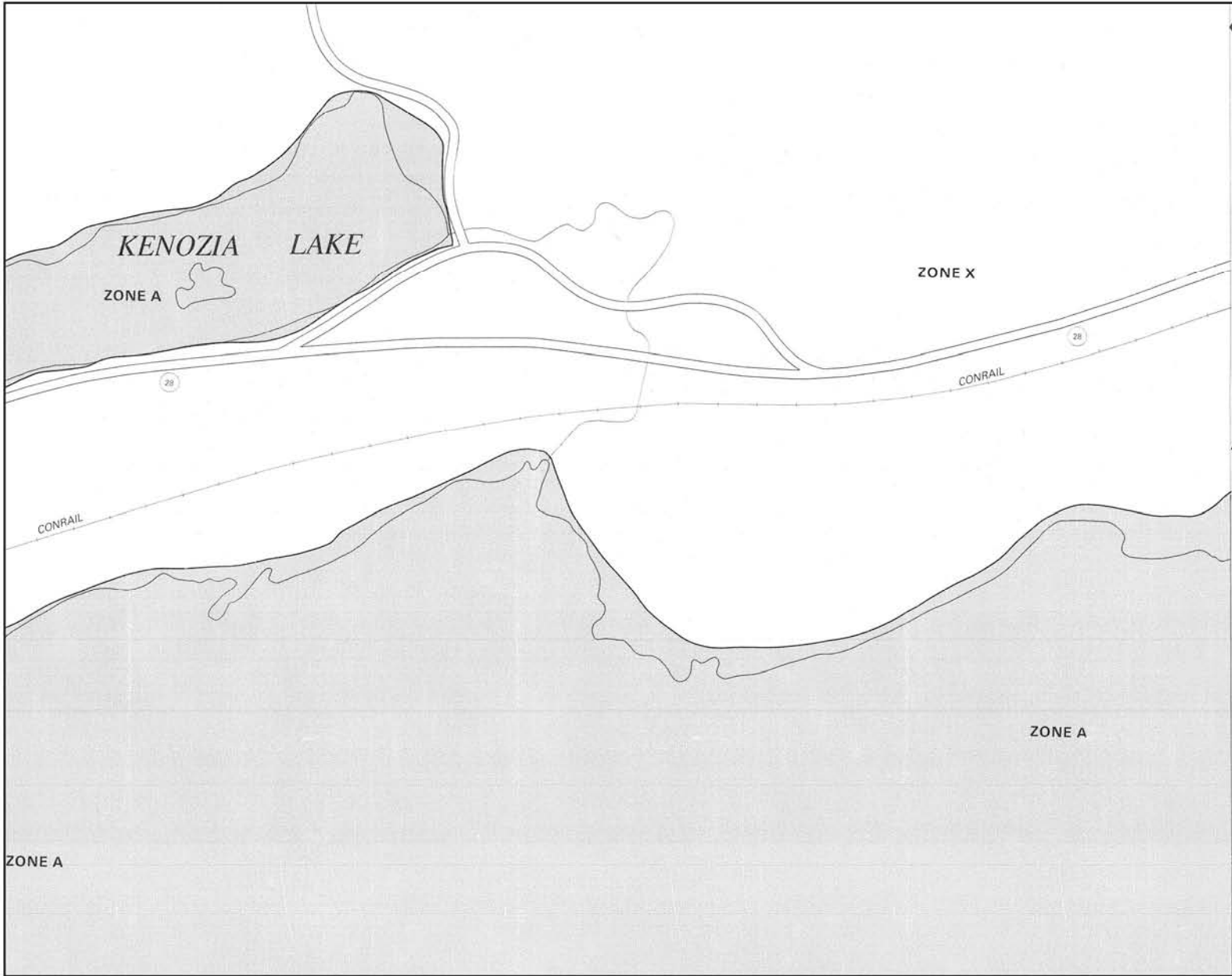

**NATIONAL FLOOD INSURANCE PROGRAM**

**FIRM**  
FLOOD INSURANCE RATE MAP

TOWN OF  
HURLEY, NEW YORK  
ULSTER COUNTY

PANEL 3 OF 10  
(SEE MAP INDEX FOR PANELS NOT PRINTED)

PANEL LOCATION

COMMUNITY-PANEL NUMBER  
.360857 0003 C

MAP REVISED:  
AUGUST 18, 1992

Federal Emergency Management Agency

LOCAL PANEL 0004

This is an official copy of a portion of the above referenced flood map. It was extracted using F-MIT On-Line. This map does not reflect changes or amendments which may have been made subsequent to the date on the title block. For the latest product information about National Flood Insurance Program flood maps check the FEMA Flood Map Store at [www.msc.fema.gov](http://www.msc.fema.gov)



**KEY TO MAP**

500-Year Flood Boundary	—	<b>ZONE B</b>
100-Year Flood Boundary	—	<b>ZONE A1</b>
Zone Designations*		<b>ZONE A5</b>
100-Year Flood Boundary	—	<b>ZONE B</b>
500-Year Flood Boundary	—	<b>ZONE B</b>
Base Flood Elevation Line With Elevation In Feet**	~~~~~ 513 ~~~~~	
Base Flood Elevation In Feet Where Uniform Within Zone**		(EL 987)
Elevation Reference Mark		RM7x
Zone D Boundary	—	
River Mile		•M1.5

\*\*Referenced to the National Geodetic Vertical Datum of 1929

**\*EXPLANATION OF ZONE DESIGNATIONS**

ZONE	EXPLANATION
<b>A</b>	Areas of 100-year flood; base flood elevations and flood hazard factors not determined.
<b>A0</b>	Areas of 100-year shallow flooding where depths are between one (1) and three (3) feet; average depths of inundation are shown, but no flood hazard factors are determined.
<b>AH</b>	Areas of 100-year shallow flooding where depths are between one (1) and three (3) feet; base flood elevations are shown, but no flood hazard factors are determined.
<b>A1-A30</b>	Areas of 100-year flood; base flood elevations and flood hazard factors determined.
<b>A99</b>	Areas of 100-year flood to be protected by flood protection system under construction; base flood elevations and flood hazard factors not determined.
<b>B</b>	Areas between limits of the 100-year flood and 500-year flood; or certain areas subject to 100-year flooding with average depths less than one (1) foot or where the contributing drainage area is less than one square mile; or areas protected by levees from the base flood. (Medium shading)
<b>C</b>	Areas of minimal flooding. (No shading)
<b>D</b>	Areas of undetermined, but possible, flood hazards.
<b>V</b>	Areas of 100-year coastal flood with velocity (wave action); base flood elevations and flood hazard factors not determined.
<b>V1-V30</b>	Areas of 100-year coastal flood with velocity (wave action); base flood elevations and flood hazard factors determined.

**NOTES TO USER**

This is an official copy of a portion of the above referenced flood map. It was extracted using F-MIT On-Line. This map does not reflect changes or amendments which may have been made subsequent to the date on the title block. For the latest product information about National Flood Insurance Program flood maps check the FEMA Flood Map Store at [www.msc.fema.gov](http://www.msc.fema.gov)

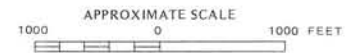

**KEY TO MAP**

500-Year Flood Boundary	Zone Designations*	<b>ZONE B</b>
100-Year Flood Boundary		<b>ZONE A1</b>
		<b>ZONE A2</b>
100-Year Flood Boundary		<b>ZONE B</b>
500-Year Flood Boundary		
Base Flood Elevation Line With Elevation in Feet**		~513
Base Flood Elevation in Feet Where Uniform Within Zone**		(EL 107)
Elevation Reference Mark		RM7c
Zone D Boundary		
River Mile		•M1.5

\*\*Referenced to the National Geodetic Vertical Datum of 1929

**\*EXPLANATION OF ZONE DESIGNATIONS**

ZONE	EXPLANATION
<b>A</b>	Areas of 100-year flood; base flood elevations and flood hazard factors not determined.
<b>A0</b>	Areas of 100-year shallow flooding where depths are between one (1) and three (3) feet; average depths of inundation are shown, but no flood hazard factors are determined.
<b>AH</b>	Areas of 100-year shallow flooding where depths are between one (1) and three (3) feet; base flood elevations are shown, but no flood hazard factors are determined.
<b>A1-A30</b>	Areas of 100-year flood; base flood elevations and flood hazard factors determined.
<b>A99</b>	Areas of 100-year flood to be protected by flood protection system under construction; base flood elevations and flood hazard factors not determined.
<b>B</b>	Areas between limits of the 100-year flood and 500-year flood; or certain areas subject to 100-year flooding with average depths less than one (1) foot or where the contributing drainage area is less than one square mile; or areas protected by levees from the base flood. (Medium shading)
<b>C</b>	Areas of minimal flooding. (No shading)
<b>D</b>	Areas of undetermined, but possible, flood hazards.
<b>V</b>	Areas of 100-year coastal flood with velocity (wave action); base flood elevations and flood hazard factors not determined.
<b>V1-V20</b>	Areas of 100-year coastal flood with velocity (wave action); base flood elevations and flood hazard factors determined.

This is an official copy of a portion of the above referenced flood map. It was extracted using F-MIT On-Line. This map does not reflect changes or amendments which may have been made subsequent to the date on the title block. For the latest product information about National Flood Insurance Program flood maps check the FEMA Flood Map Store at [www.msc.fema.gov](http://www.msc.fema.gov)

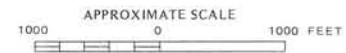

**KEY TO MAP**

500-Year Flood Boundary	—	<b>ZONE B</b>
100-Year Flood Boundary	—	<b>ZONE A1</b>
Zone Designations*		<b>ZONE A2</b>
		<b>ZONE B</b>
100-Year Flood Boundary	—	<b>ZONE B</b>
500-Year Flood Boundary	—	
Base Flood Elevation Line With Elevation in Feet**	—513	
Base Flood Elevation in Feet Where Uniform Within Zone**	(EL. 887)	
Elevation Reference Mark	RM7c	
Zone D Boundary	—	
River Mile	•M1.5	

\*\*Referenced to the National Geodetic Vertical Datum of 1929

**\*EXPLANATION OF ZONE DESIGNATIONS**

ZONE	EXPLANATION
<b>A</b>	Areas of 100-year flood; base flood elevations and flood hazard factors not determined.
<b>A0</b>	Areas of 100-year shallow flooding where depths are between one (1) and three (3) feet; average depths of inundation are shown, but no flood hazard factors are determined.
<b>AH</b>	Areas of 100-year shallow flooding where depths are between one (1) and three (3) feet; base flood elevations are shown, but no flood hazard factors are determined.
<b>A1-A30</b>	Areas of 100-year flood; base flood elevations and flood hazard factors determined.
<b>A99</b>	Areas of 100-year flood to be protected by flood protection system under construction; base flood elevations and flood hazard factors not determined.
<b>B</b>	Areas between limits of the 100-year flood and 500-year flood; or certain areas subject to 100-year flooding with average depths less than one (1) foot or where the contributing drainage area is less than one square mile; or areas protected by levees from the base flood. (Medium shading)
<b>C</b>	Areas of minimal flooding. (No shading)
<b>D</b>	Areas of undetermined, but possible, flood hazards.
<b>V</b>	Areas of 100-year coastal flood with velocity (wave action); base flood elevations and flood hazard factors not determined.
<b>V1-V20</b>	Areas of 100-year coastal flood with velocity (wave action); base flood elevations and flood hazard factors determined.

This is an official copy of a portion of the above referenced flood map. It was extracted using F-MIT On-Line. This map does not reflect changes or amendments which may have been made subsequent to the date on the title block. For the latest product information about National Flood Insurance Program flood maps check the FEMA Flood Map Store at [www.msc.fema.gov](http://www.msc.fema.gov)



**KEY TO MAP**

500-Year Flood Boundary	—	<b>ZONE B</b>
100-Year Flood Boundary	—	<b>ZONE A1</b>
Zone Designations*		<b>ZONE A2</b>
		<b>ZONE A3</b>
100-Year Flood Boundary	—	<b>ZONE B</b>
500-Year Flood Boundary	—	
Base Flood Elevation Line With Elevation in Feet**	— 613 —	
Base Flood Elevation in Feet Where Uniform Within Zones**	(EL 607)	
Elevation Reference Mark	RM7 <sub>x</sub>	
Zone D Boundary	—	
River Mile	•M1.5	

\*\*Referenced to the National Geodetic Vertical Datum of 1929

**\*EXPLANATION OF ZONE DESIGNATIONS**

ZONE	EXPLANATION
A	Areas of 100-year flood; base flood elevations and flood hazard factors not determined.
A0	Areas of 100-year shallow flooding where depths are between one (1) and three (3) feet; average depths of inundation are shown, but no flood hazard factors are determined.
AH	Areas of 100-year shallow flooding where depths are between one (1) and three (3) feet; base flood elevations are shown, but no flood hazard factors are determined.
A1A30	Areas of 100-year flood; base flood elevations and flood hazard factors determined.
AB9	Areas of 100-year flood to be protected by flood protection system under construction; base flood elevations and flood hazard factors not determined.
B	Areas between limits of the 100-year flood and 500-year flood; or certain areas subject to 100-year flooding with average depths less than one (1) foot or where the contributing drainage area is less than one square mile; or areas protected by levees from the base flood. (Medium shading)
C	Areas of minimal flooding. (No shading)
D	Areas of undetermined, but possible, flood hazards.
V	Areas of 100-year coastal flood with velocity (wave action); base flood elevations and flood hazard factors not determined.
V1-V20	Areas of 100-year coastal flood with velocity (wave action); base flood elevations and flood hazard factors determined.

This is an official copy of a portion of the above referenced flood map. It was extracted using F-MIT On-Line. This map does not reflect changes or amendments which may have been made subsequent to the date on the title block. For the latest product information about National Flood Insurance Program flood maps check the FEMA Flood Map Store at [www.msc.fema.gov](http://www.msc.fema.gov)